

WIGLEY FAMILY HISTORY

NOTE

- this is only a simplified family tree, designed primarily to show the author's ancestors, and is by no means complete or fully updated - up-to-date information can be found in various trees on Ancestry (although these are not always reliable)
- the Author has attempted to show all people born with the surname Punyer, and descent of male Punyers, but sometimes only brief details of females' families

NEW
2022

GREY AREA
the information about these generations has been taken from trees on Ancestry which however provide absolutely no sources

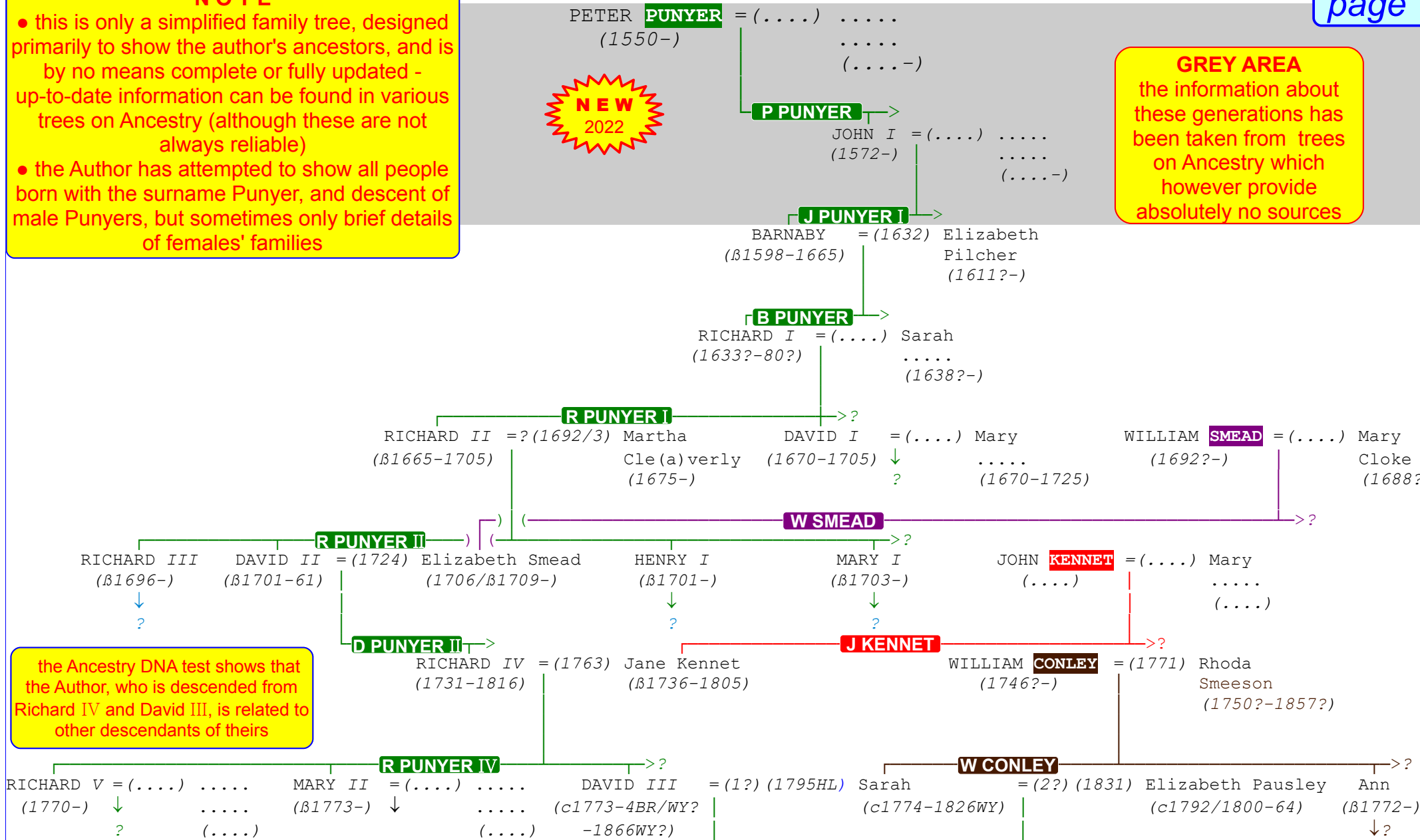

the Ancestry DNA test shows that the Author, who is descended from Richard IV and David III, is related to other descendants of theirs

D PUNYER III (1)

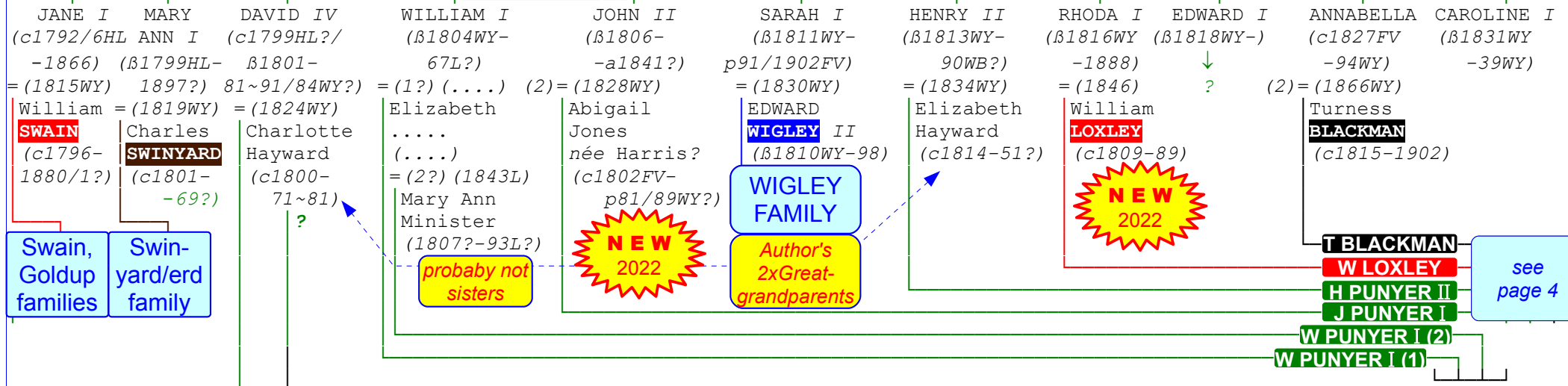

D PUNYER IV

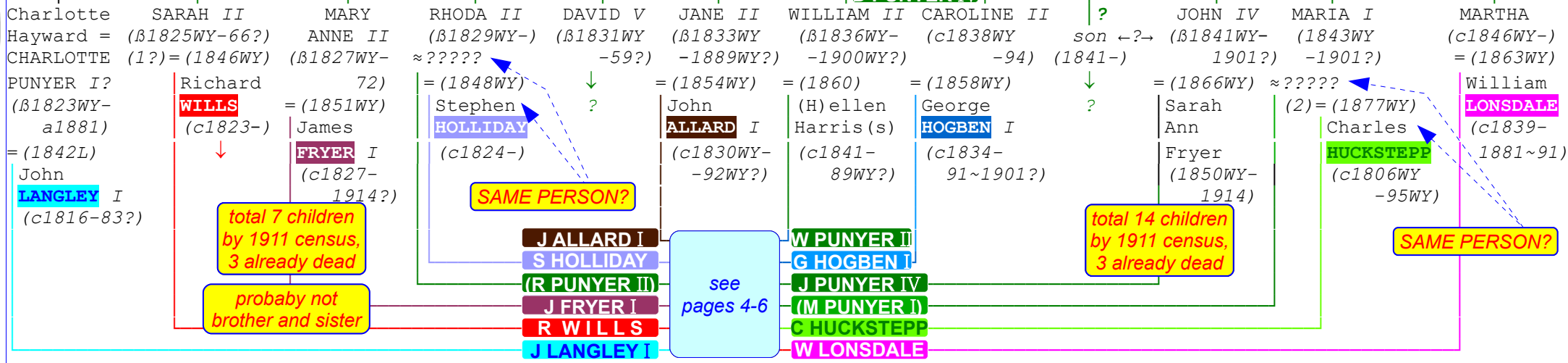

W PUNYER I (1)

W PUNYER I (2)

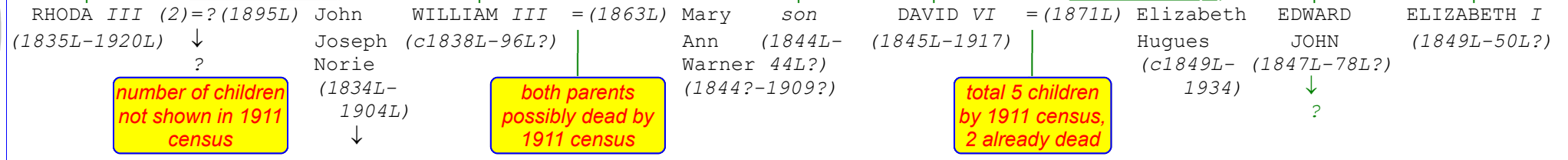

W PUNYER III

D PUNYER VI

RHODA IV (1863L) ELLEN I = (1888L) (1864L-1918) Benjamin STEVENSON (....) MARY = (1891L) (1867-1951) ANN V Thomas DUKES (....) WILLIAM = (1899) (1870L-1923) DAVID Agnes M(acdonald?) Ashford (1875-1914) JAMES I (1873L) (1875L-1927L?) JOHN VII (2) = (1918L) Ellen Davis née Downes (1888?-1957L) son ISABELLA (1880L-1960) Charles ILSLEY (....) RICHARD VI = (1) (1908) Alice ?Bowles (c1885-1910) (2) = (2) (1919) Harriette Elizabeth Coleman née Letch (1892-1970)

possibly 7 children, definitely 1 daughter SCOTLAND

NEW 2022

J PUNYER VII

R PUNYER VI

NEW 2022

JOHN = (1950) Vera LILIAN = (1949) Arthur HELEN = (1939) Leslie MAY = (1945) Thomas HENRY (1922-99) D.... Hardy (....) ELIZABETH (1924-94) J.... T.... TATNELL (....) E.... (1920-51?) ? J.... Waters (....) FLORENCE (1922-51?) J.... MILROY (....)

1 daughter

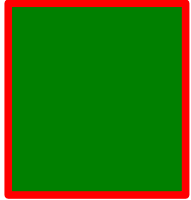

D PUNYER VI

DAVID VII = (1898) Emma Underwood (c1872-1946) ANNIE LOUISA (1874-87) ELIZABETH MARY (1877-80) WILLIAM THOMAS (1880-1916u?) JESSIE ALICE (1884-1960?) Charles BOND (....)

D PUNYER VII

LAURA (1899-1976u) KATHLEEN UNDERWOOD (1901-58?) William KING (....) EDWIN JOSIAH (1904-5) ARTHUR = (1932) Mary. Anne. Brod-iston (1903-96) OLGA = (1929) Wilfred S.... HIGNETT (....) PHYLIS JOAN (1909-74) Alfred G.... SHEPHERD (....)

JH PUNYER

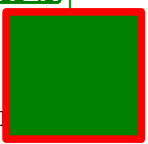

NEW 2022

A PUNYER

ARTHUR =? (2000) Margaret M(ary?) Dunne (1932-2018?) ? ALAN =? (19..) D.... (1934-)

AD PUNYER

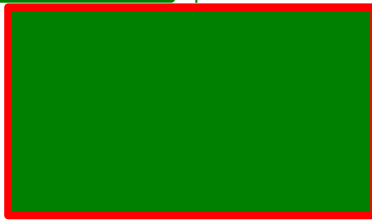

see page 2

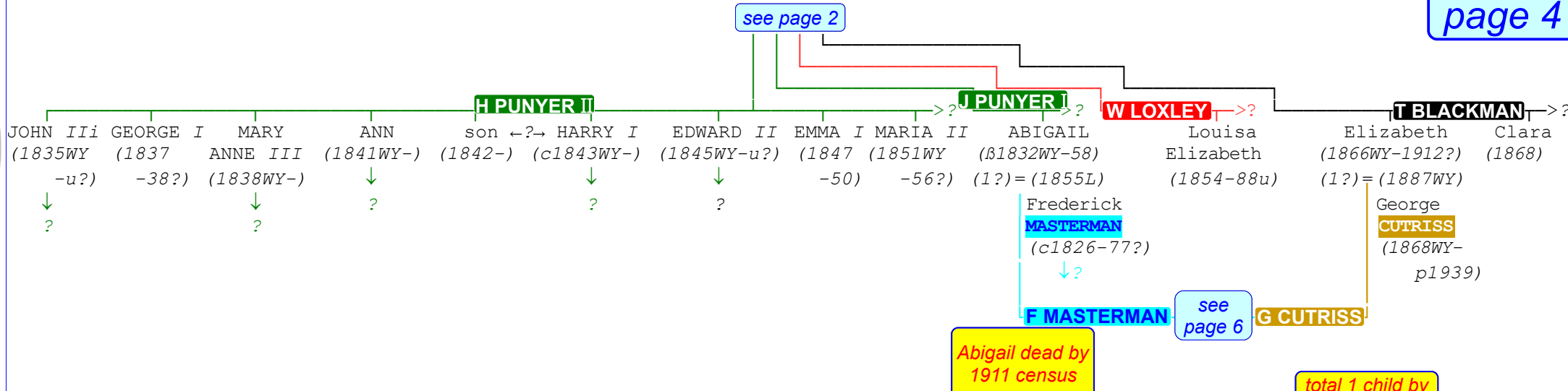

Abigail dead by 1911 census

total 1 child by 1911 census, alive

see page 2

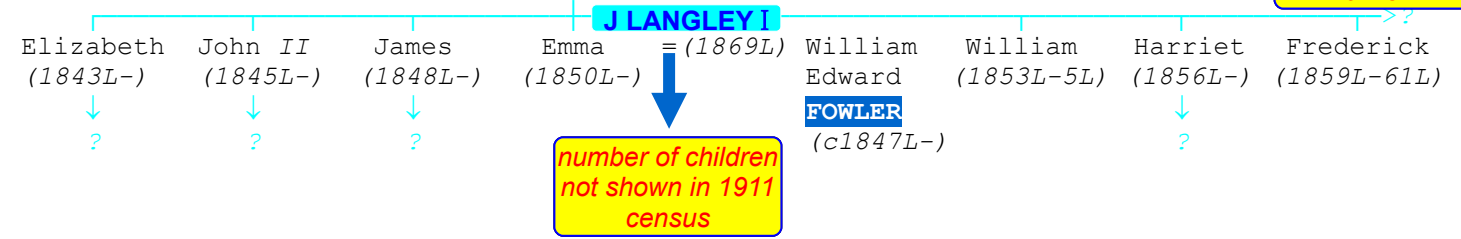

number of children not shown in 1911 census

see page 2

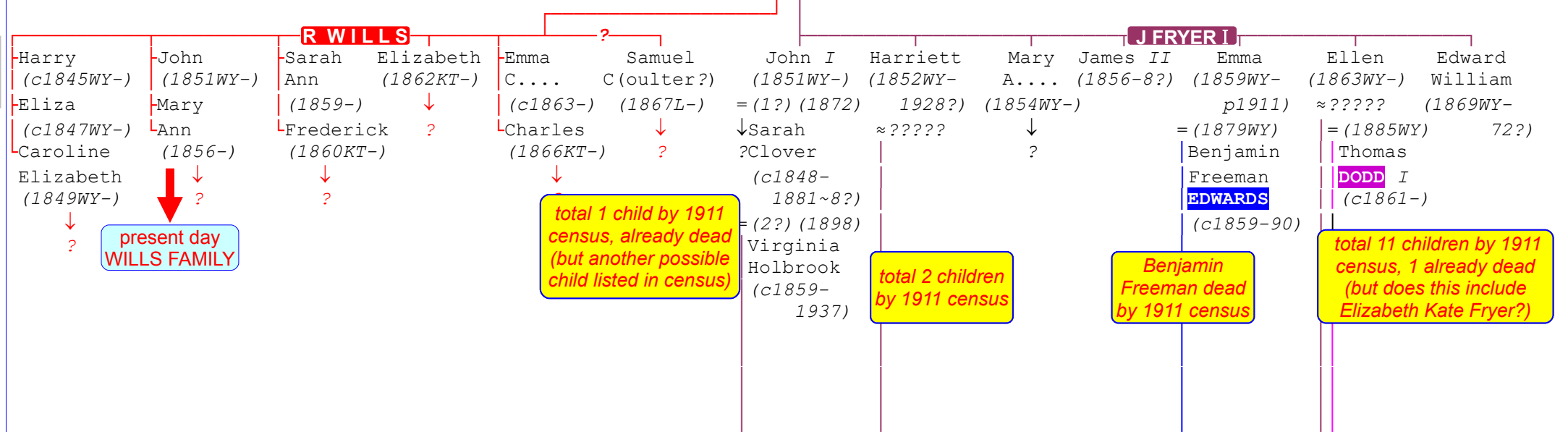

present day WILLS FAMILY

total 1 child by 1911 census, already dead (but another possible child listed in census)

total 2 children by 1911 census

Benjamin Freeman dead by 1911 census

total 11 children by 1911 census, 1 already dead (but does this include Elizabeth Kate Fryer?)

12

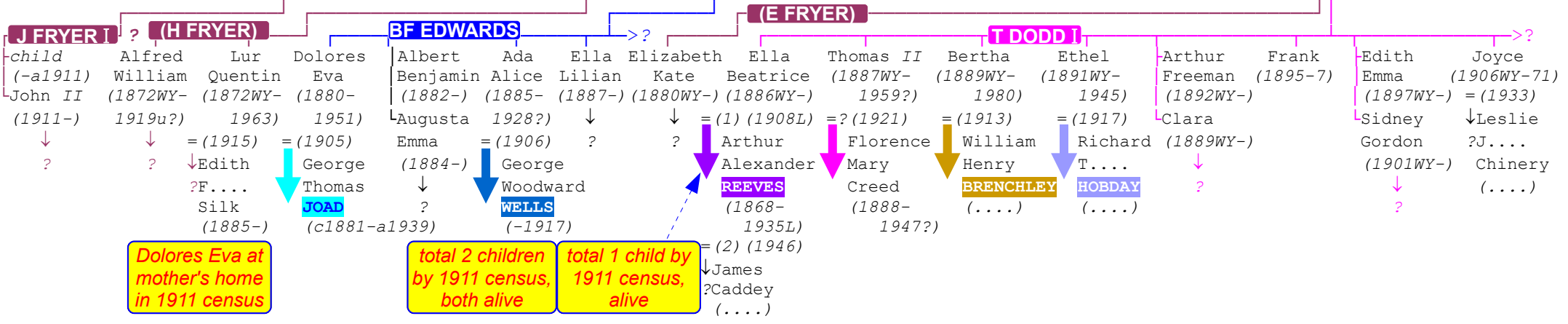

11

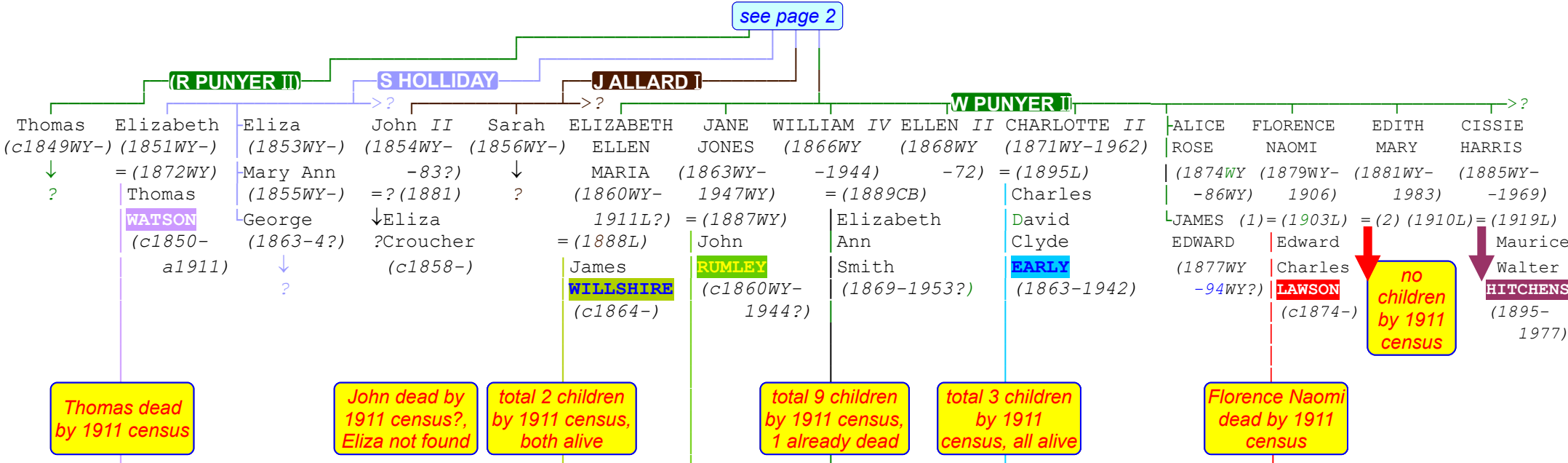

12

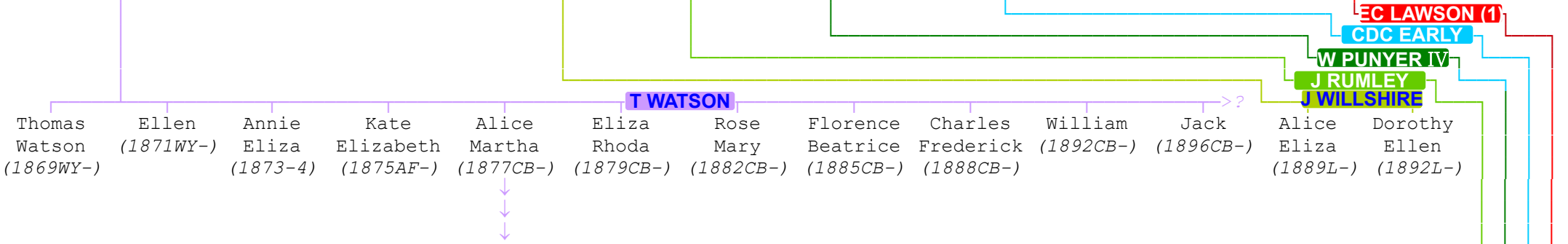

12

13

11

J RUMLEY

W PUNYER IV

Elizabeth Charlotte (1888WY-)	Edith Ellen (1891WY-)	William (1894WY-)	Dorothy Mabel (1896WY-)	Frank (1898WY-)	Cissie Alice (1903WY-)	ELLEN III (1890WY-1985)	MABEL (1891WY-?)	JAMES II (1894)	EDITH VIOLET (1896WY-1991)	WILLIAM V (1899WY-1972)	FLORENCE ELIZABETH (1902WY-92)	DORIS (1904WY-94)	CHARLES GEORGE (1907WY-90)	GLADYS (1909WY-22)
						= (1914)			= (1922WY)	= (1930)	= (1929)	= (1931)		
						↓ Louis E.... SHARP (-a1939)			↓ (1926WY) George John STEED (1902-75)	Edith Frances Jane Luckett (1902-55)	↓ William C.... SHAXTED (....)	↓ Alec EDENDEN (....)	↓ Caroline ?Ethel Trigg (1903-52)	

W PUNYER V

PUNYER

CDC EARLY

EC LAWSON (1)

JOAN (1922)	MARJORIE (1927-50?)	EDITH (1928)	FRANCES (1928)	ROY (1931-2018)	(1) = (1) (1957)	[REDACTED]	[REDACTED]	DORIS EDNA (1919-)	Alice Vera (1896-1986)	Charles Clyde (1898-1971)	Cecil David (1905-79)	Naomi Edith (1904-87?)
	↓ William ?G.... Allard (....)							↓ ?	↓	↓	↓	↓ ?



R PUNYER



see page 2

G HOGBEN I

J PUNYER IV

(M PUNYER I)

C HUCKSTEPP

F MASTERMAN

W LONSDALE

G CUTRISS

Elizabeth (1860KT-64/7/a71?)	Richard (1863KT-1940?)	George II (1864-)	Emma (II) (c1860CB-)	John (V) (1863WY-1923?)	Elizabeth (II) (1865-6)	Alicia (1872)	Alice (1879WY-)	George (1880WY-)	Emma (1863AF-)	Frederick John (1856)	Lilian (1888MS-)
↓ ?	= (1887)	William (1866-7?)	?	= (1892)	Jane (III) (1868WY-)	Harry (II) (1873WY-)	≈ ?????	Ellen (1884WY-)	?	William (1856)	↓
	Rosaline Hadaway (1866?-95)	Harry (1867AF-97?)		↓ Charlotte ?Fisher (c1859-1910)	Ada (1872WY-)	Alfred [HUCKSTEPP] (1876WY-1946WB)		Margaret (1885WY-)		Henrietta Abigail (1857WY-1867?)	

11

11

12

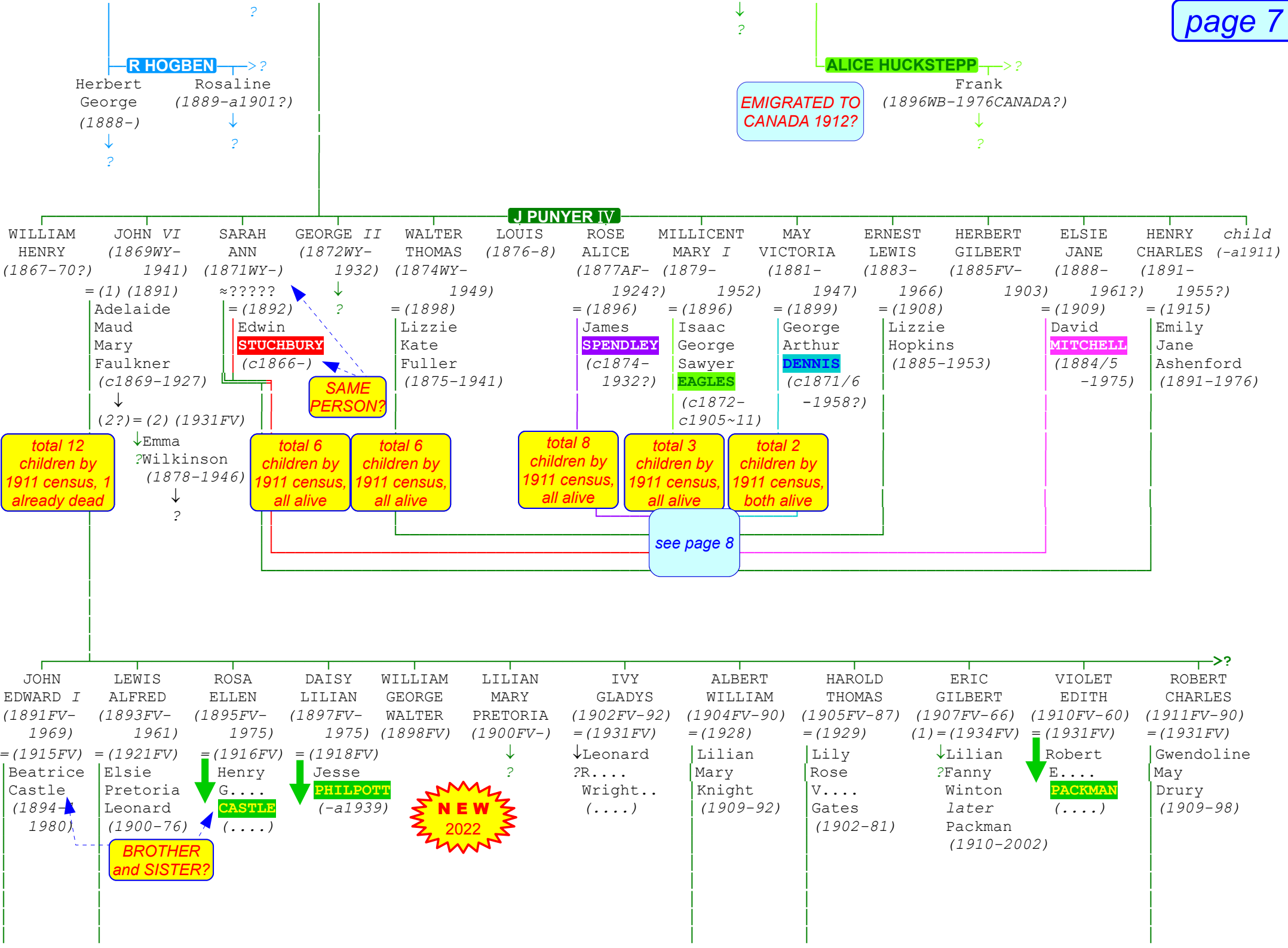

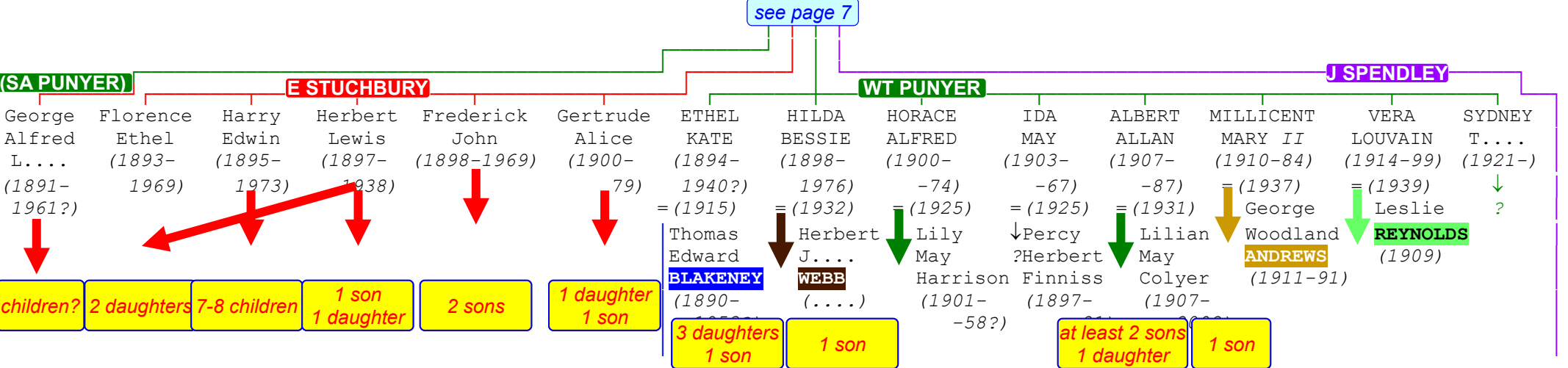
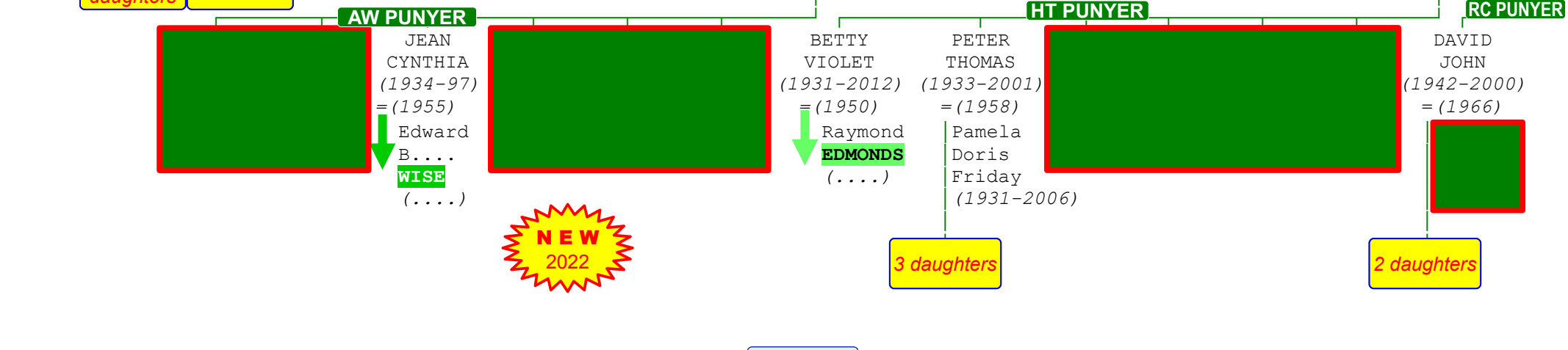
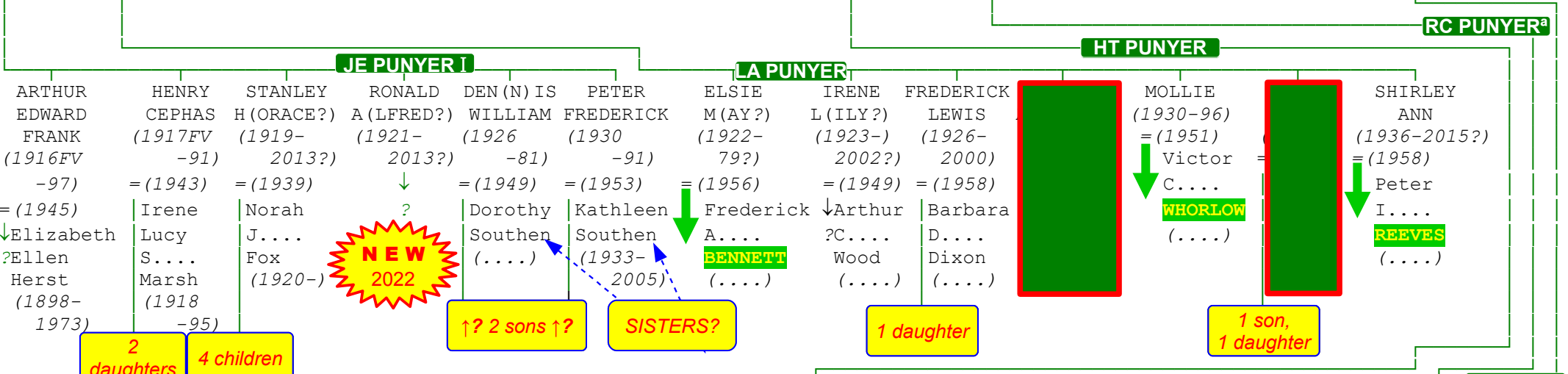

13

12

12

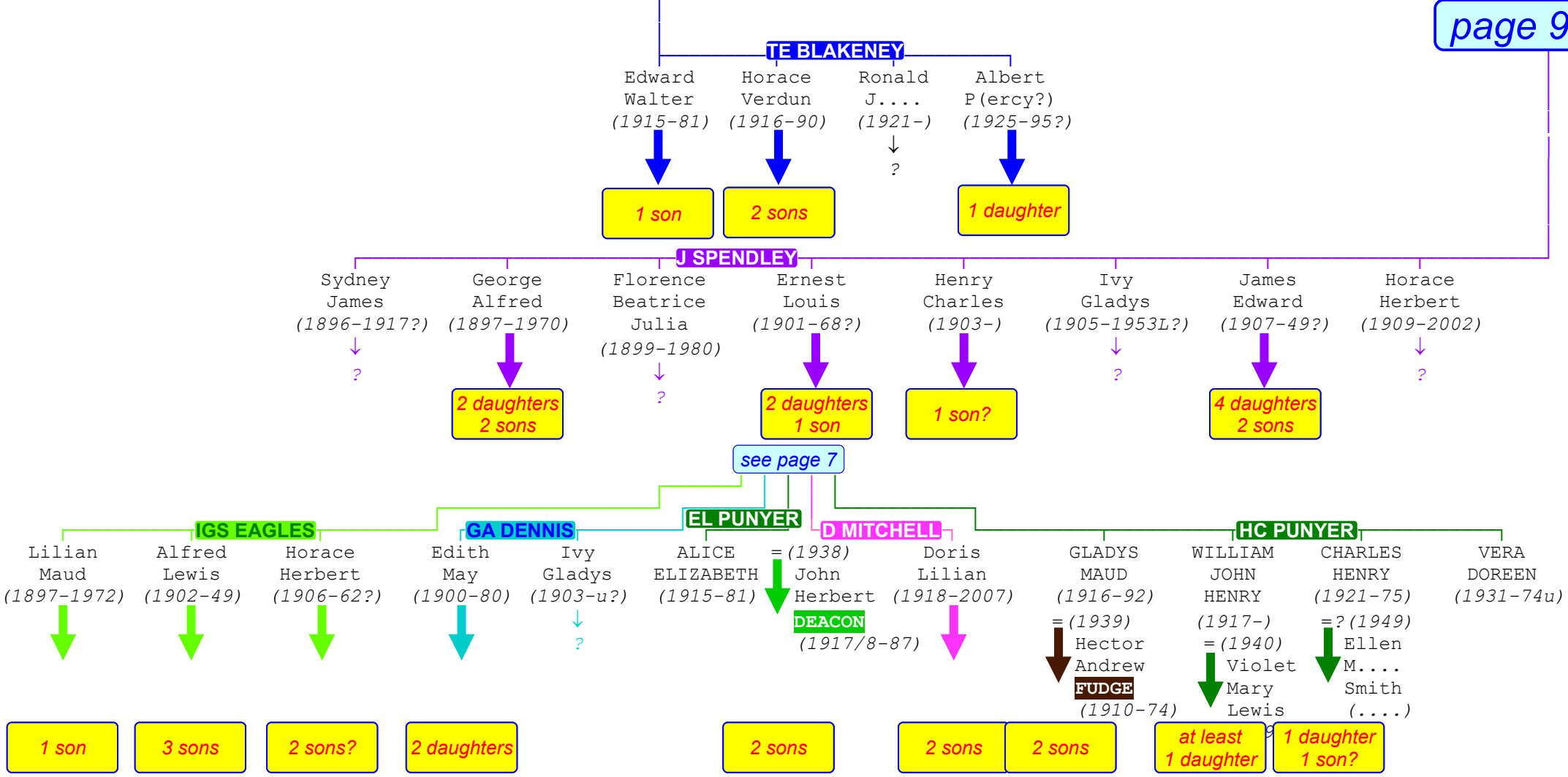

AF Ashford, Kent **B** baptized (exact year of birth not known)
BR Brook, Kent = married ≠ divorced
CB Canterbury, Kent **c** approximately **a** before **p** after
FV Faversham, Kent **u** (after date of death) unmarried
HL Hastingleigh, Kent **(1) (2)** (for marriages) firstly, secondly, etc.
KT Kennington, Kent (for children) first, second born, etc.
L London, Middx ↓ not known whether any children
MS Maidstone, Kent ?
WB Willesborough, Kent →? not known whether any other children
WY Wye, Kent

LES DURHAM7@GMAIL.COM