

**G R A F L I T E**

***INSTRUCTION MANUAL***

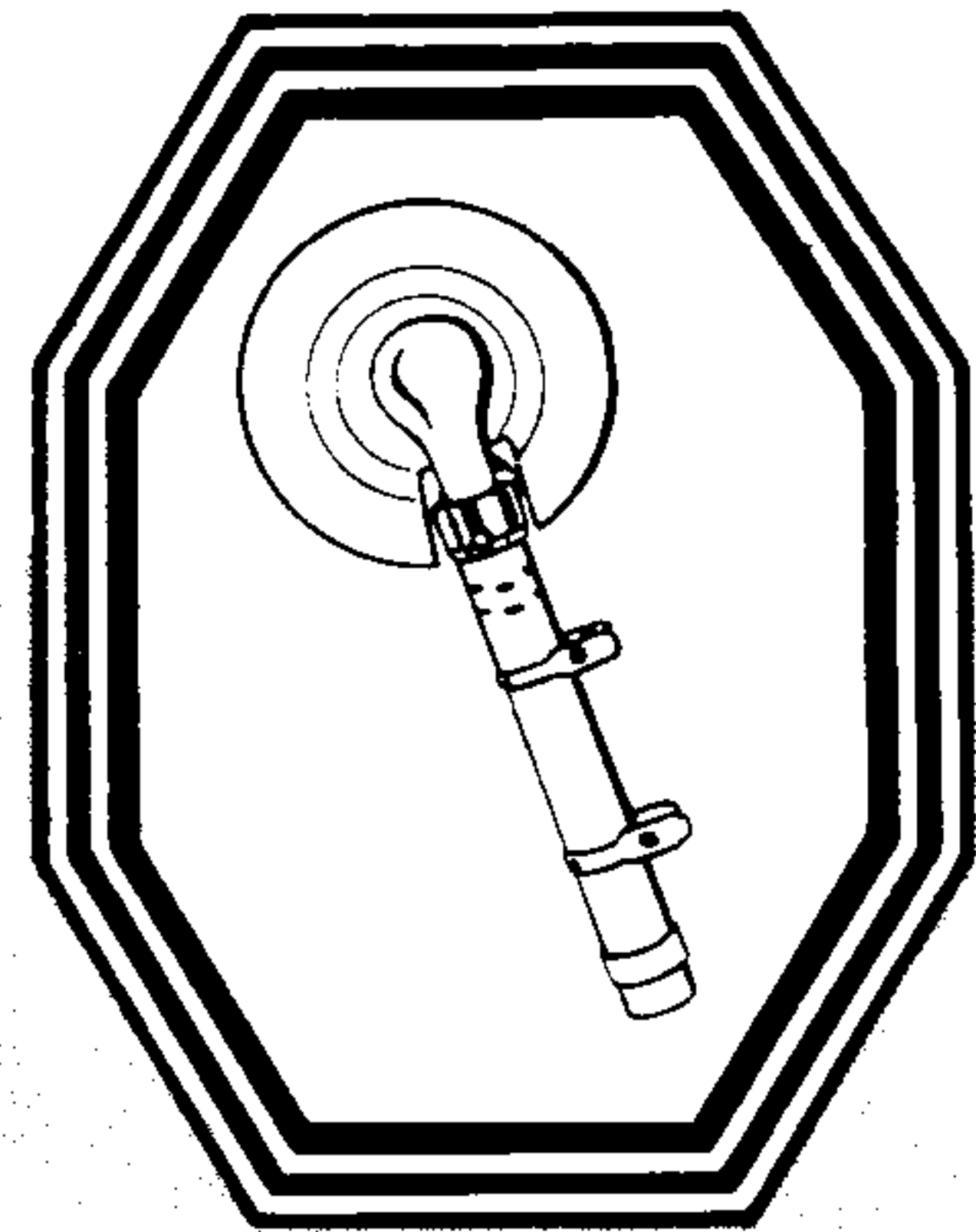

**G R A F L I T E**

*By*

**G R A F L E X**

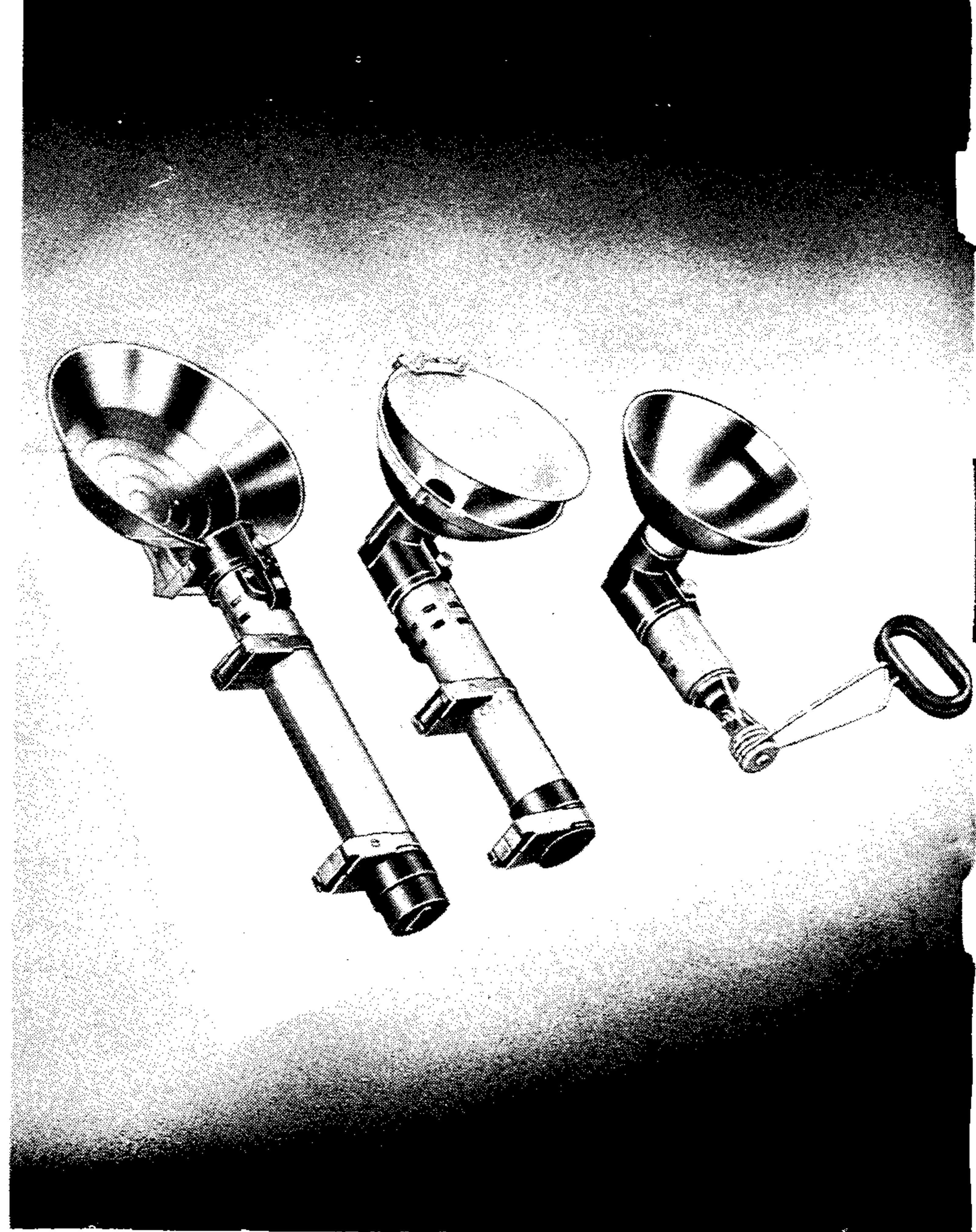

# ***SIMPLIFIED OPERATING INSTRUCTIONS***

## **SOLENOID OPERATED SHUTTER**

1. Attach the battery case to camera and plug solenoid cord (#2703 or 2704) into solenoid and SOLENOID outlet. Check to make certain that circuit control is at "N".
2. Insert flash lamp into reflector. Check adjustment of reflector for lamp used.
3. Set lens aperture and shutter speed according to manufacturers' recommendation for lamp and film being used.
4. Cock shutter and check final focus of lens.
5. Remove slide from film receptacle.
6. Make the exposure by "push or pull" operation of the red micromatic switch on the battery case.
7. Replace slide and eject lamp from reflector.
8. Change film for next exposure.

## **BUILT-IN SYNCHRONIZED SHUTTERS**

1. Attach battery case to camera and plug shutter cord (#2701 or #2702) onto the contact posts on synchronized shutter and into SHUTTER outlet in battery case. Check to make certain that circuit control is at "N".
2. Insert flash lamp into reflector. Check adjustment of reflector for lamp used.
3. Set lens aperture, shutter speed and built-in-synchronization control according to manufacturers' recommendations for lamp and film being used.
4. Cock shutter (if necessary, cock synchronizer lever additionally). Check final focus of lens.
5. Remove slide from film receptacle.
6. Make exposure by releasing shutter. (Do not press the red micromatic switch on the battery case).
7. Replace slide and eject lamp from reflector.
8. Change film for next exposure.

# **G R A F L I T E   S Y N C H R O N I Z E R**

This includes either a two or three cell battery case\*with batteries, a 5" or 7" reflector, a 17" solenoid cord, and a solenoid release with release mount. The battery case mounting device must be selected additionally as required by the camera with which the GRAFLITE Battery Case is to be used. The complete GRAFLITE Synchronizer is intended for use with X-type and non-synchronized shutters where the use of a solenoid is required in order to provide synchronization and for electrical release for synchronized GRAPHEX Shutters.

# **G R A F L I T E   U N I T**

This includes either a two or three cell battery case\* with batteries and a 5" or 7" reflector. The battery case mounting device and connecting cord must be selected additionally as required by the camera and shutter with which the GRAFLITE Battery Case is to be used. The GRAFLITE Unit is intended for use with synchronized shutters, either front (between-the-lens) or focal plane.

\*These battery cases have been developed for use with low voltages supplied by dry cell batteries. DO NOT USE WITH 110 VOLTS.



7" or 5" reflector  
2 or 3 cell battery case  
batteries  
solenoid  
solenoid mount  
17" solenoid cord  
(Battery case mounting device  
obtainable separately  
as required by Camera).

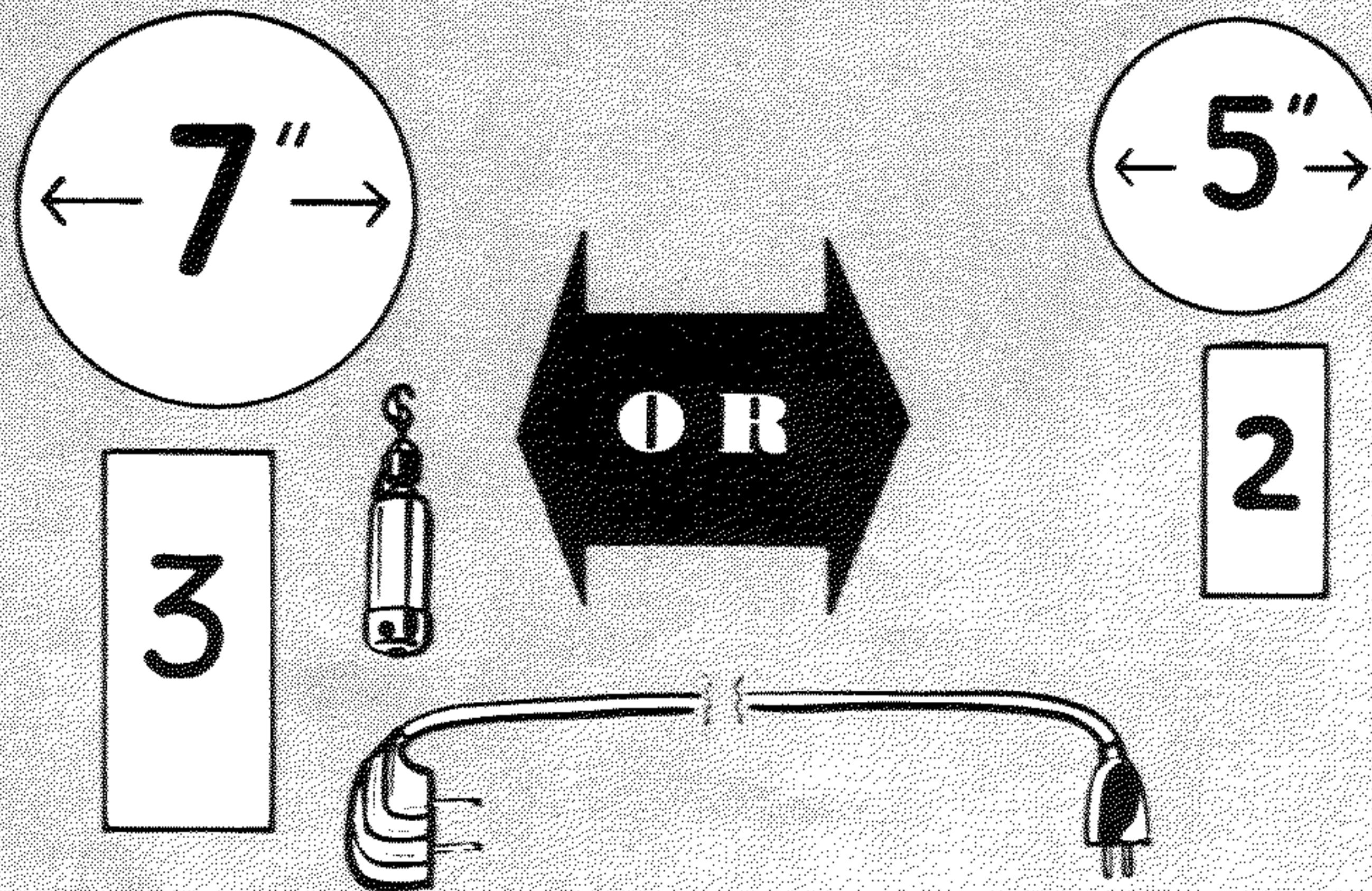

7" or 5" reflector  
2 or 3 cell battery case  
batteries  
(connecting cord and battery case  
mounting device obtainable separately  
as required by camera and shutter)

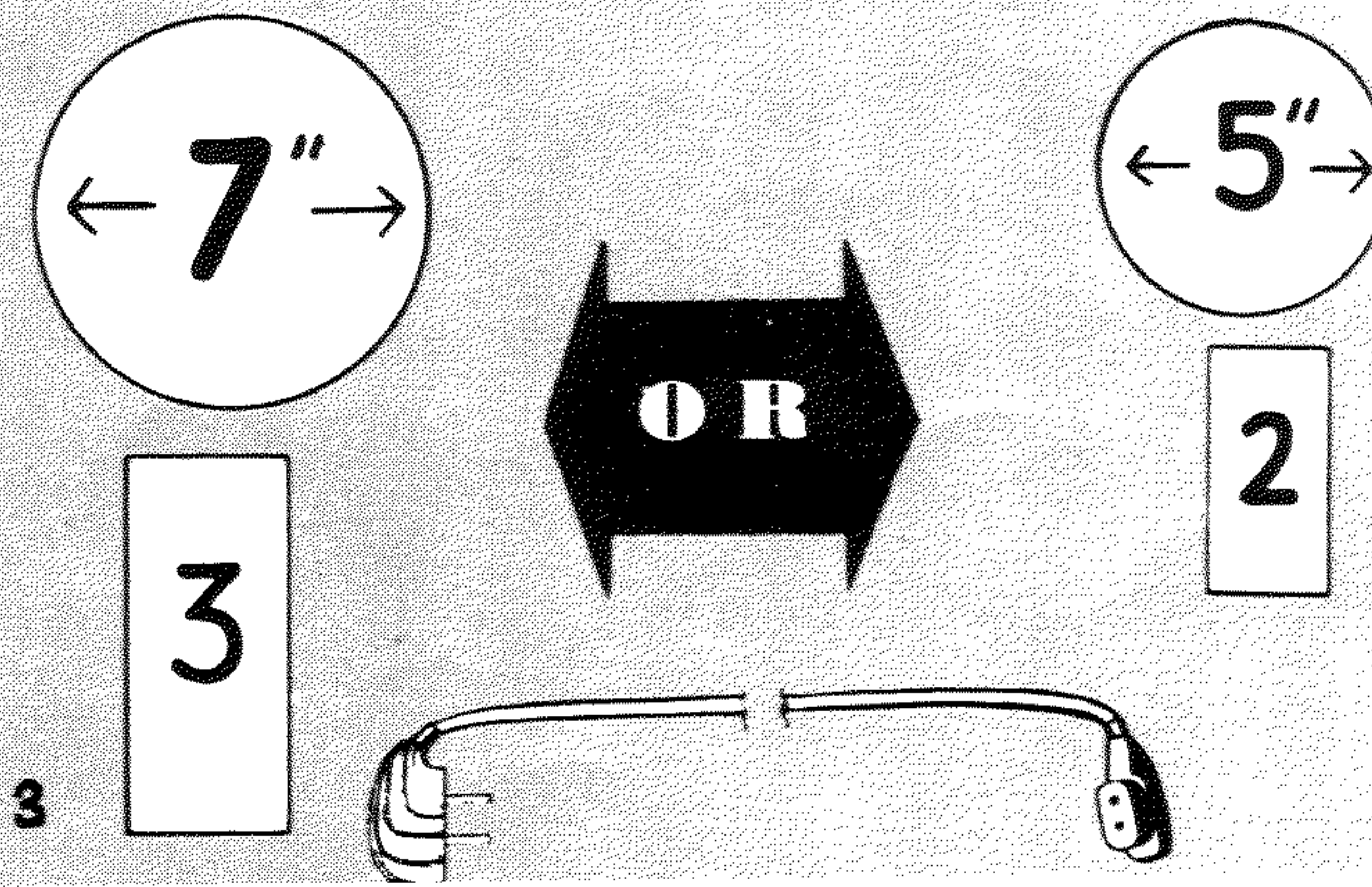

## ***FITTING TO CAMERAS***

**1**

**RIGHT HAND**—If your camera has a rangefinder encircling bracket, the GRAFLITE Mounting Plate will already be attached. Otherwise, the battery case support must be attached directly to the camera body.

**2**

**LEFT HAND AND DUAL**—The Pacemaker Handle Lugs are designed to receive the battery case clamps for left side mounting when the handle has been removed. To change or adjust the position of the battery case clamps, loosen the locking screw in each clamp sufficiently to allow the clamp to move freely. After the adjustment has been made, tighten the locking screws securely (see page 7 for detailed instructions). The left and right mount installation may be used to attach two battery cases to a single camera. Through the use of the numerous outlets thus provided, a greater number of useful power hookups are obtainable.

**3**

**GRAFLEX CAMERAS**—The GRAFLITE Battery Case may be used with GRAFLEX Cameras by means of the mounting plate attached directly to the camera body.

**4**

**OTHER CAMERAS**—The GRAFLITE Battery Case may be used with other than GRAFLEX-made cameras by means of the L-Bracket and the Platform Bracket.





1

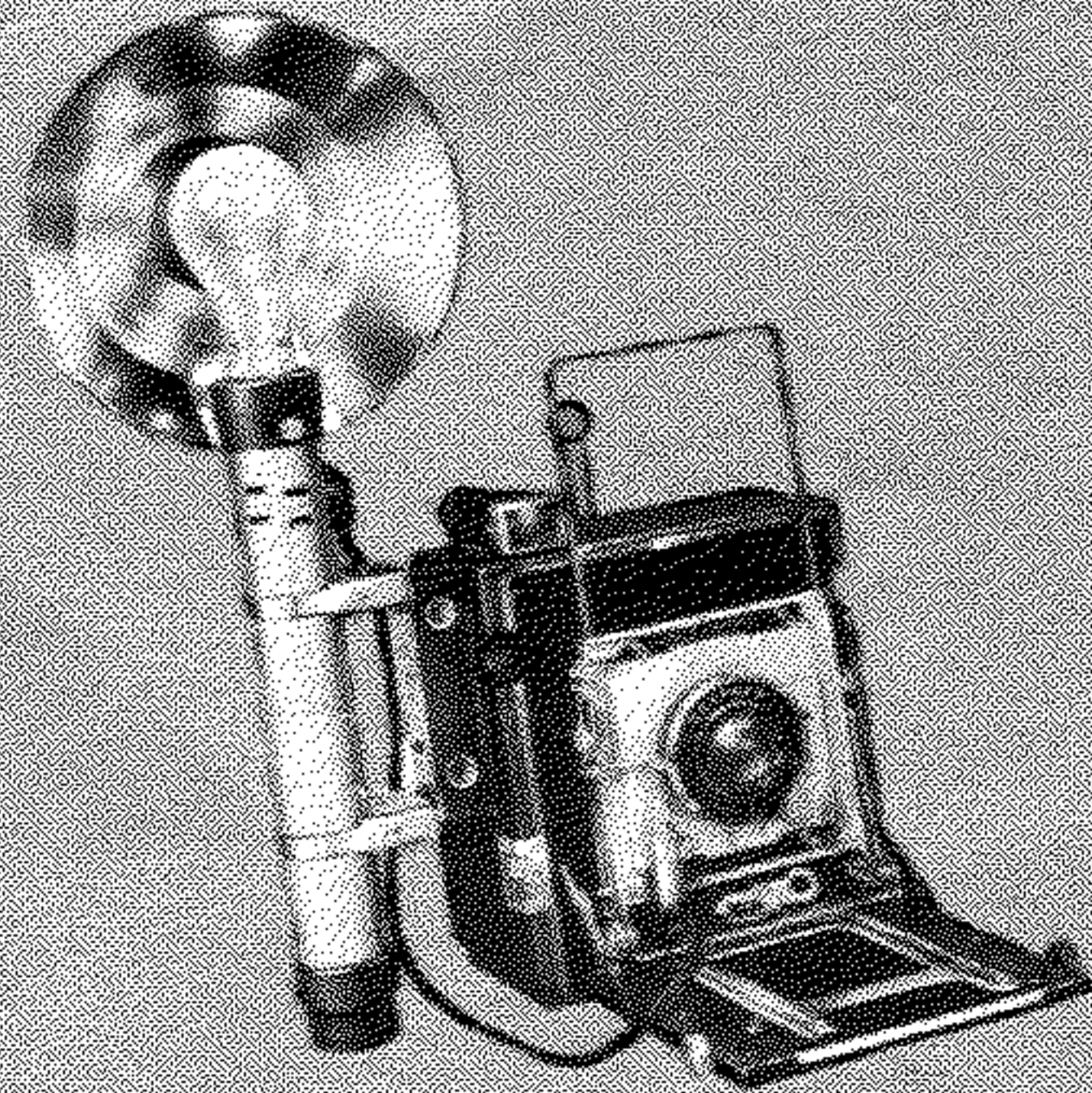

2

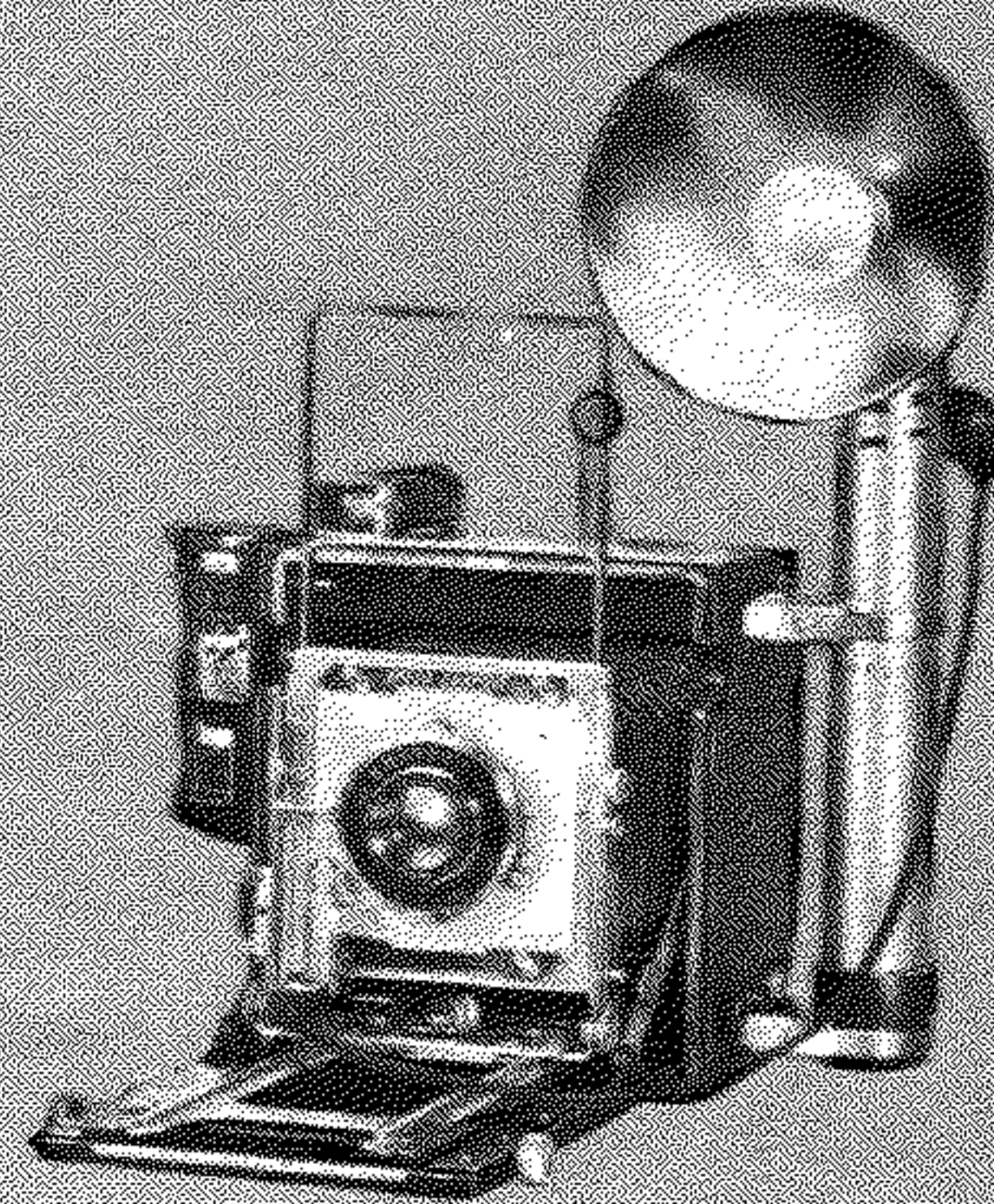

3

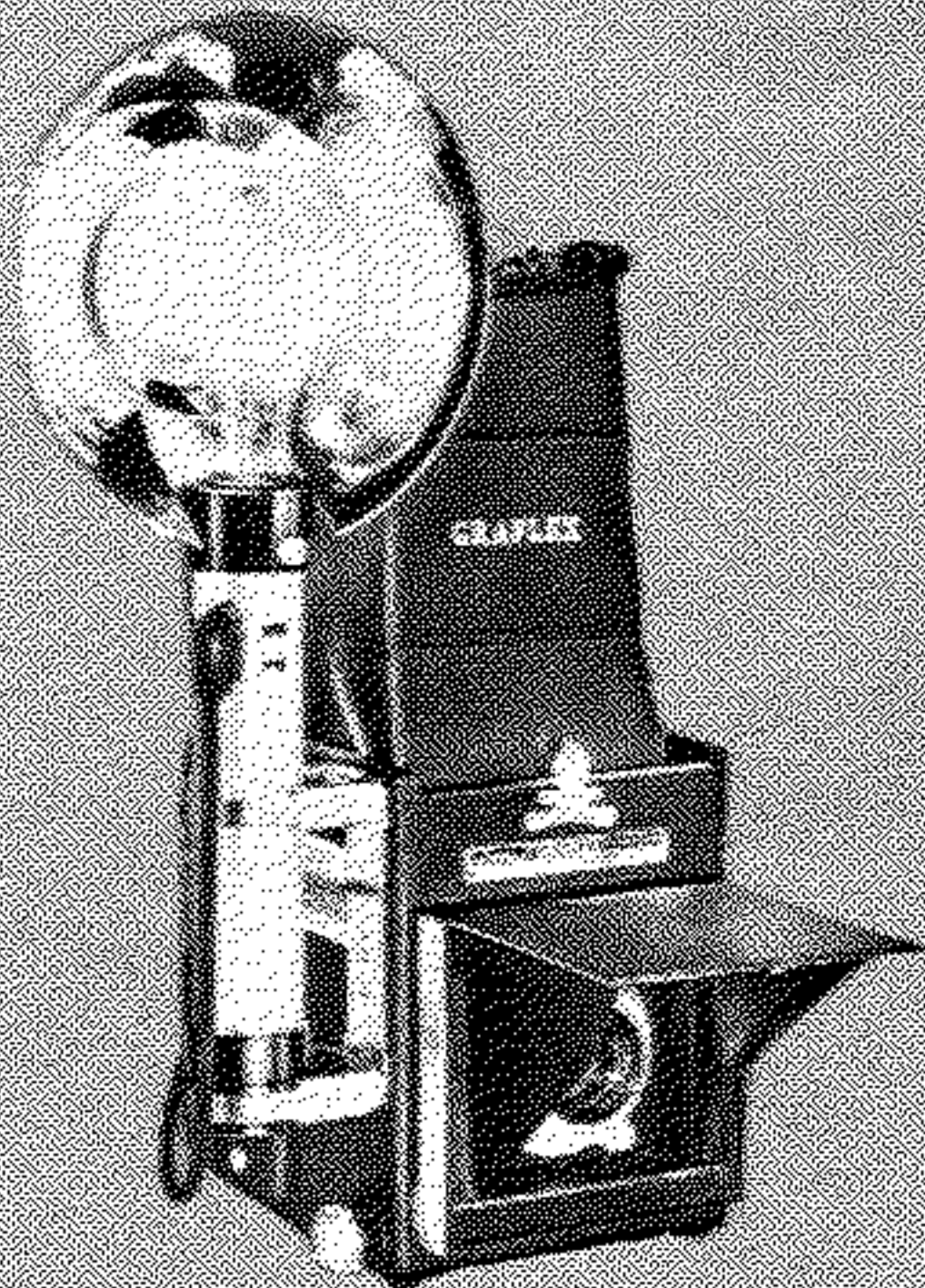

4

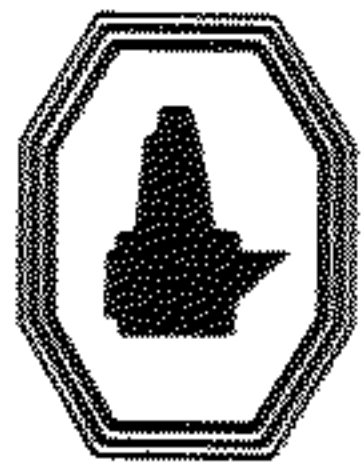
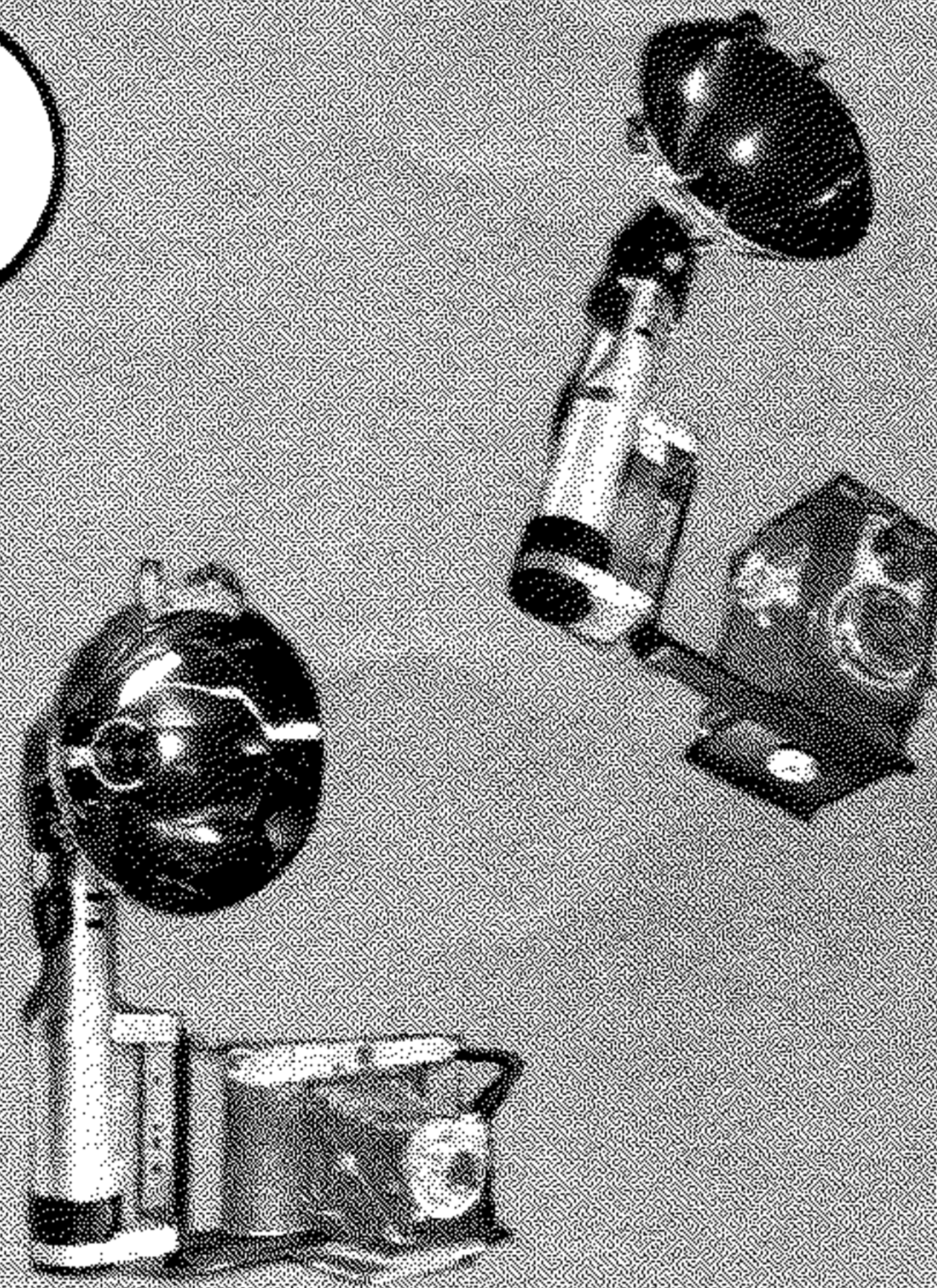



## **MOUNTING DEVICES**

**ENCIRCLING BRACKETS**—*Cat. No. 2753*—Designed for Pacemaker Speed and Crown GRAPHIC "34" and "45" cameras, these brackets provide a rigid platform for the GRAFLITE Battery Case and also protect the Kalart and Hugo Meyer Rangefinders from accidental blows.

*Cat. No. 2752*—Encircling Bracket, same as #2753 above, but designed to fit  $3\frac{1}{4}\times 4\frac{1}{4}$  and 4x5 Anniversary Speed GRAPHIC Cameras.

**MOUNTING PLATE**—*Cat. No. 2754*—This plate can be attached directly to the side of various cameras. For GRAPHIC Cameras without rangefinder, use mounting bracket, *Cat. No. 2755*, supplied complete with mounting screws and instructions to insure proper attachment.

**HANDLE LUGS**—*Cat. No. 2756*—Each Pacemaker Speed and Crown GRAPHIC and Century GRAPHIC is fitted with these dual purpose lugs, which serve both as supports for the handle as well as GRAFLITE Battery Cases. These lugs may be purchased separately through your GRAFLEX Dealer for mounting a GRAFLITE Battery Case to the right side of the Century GRAPHIC or onto other cameras.

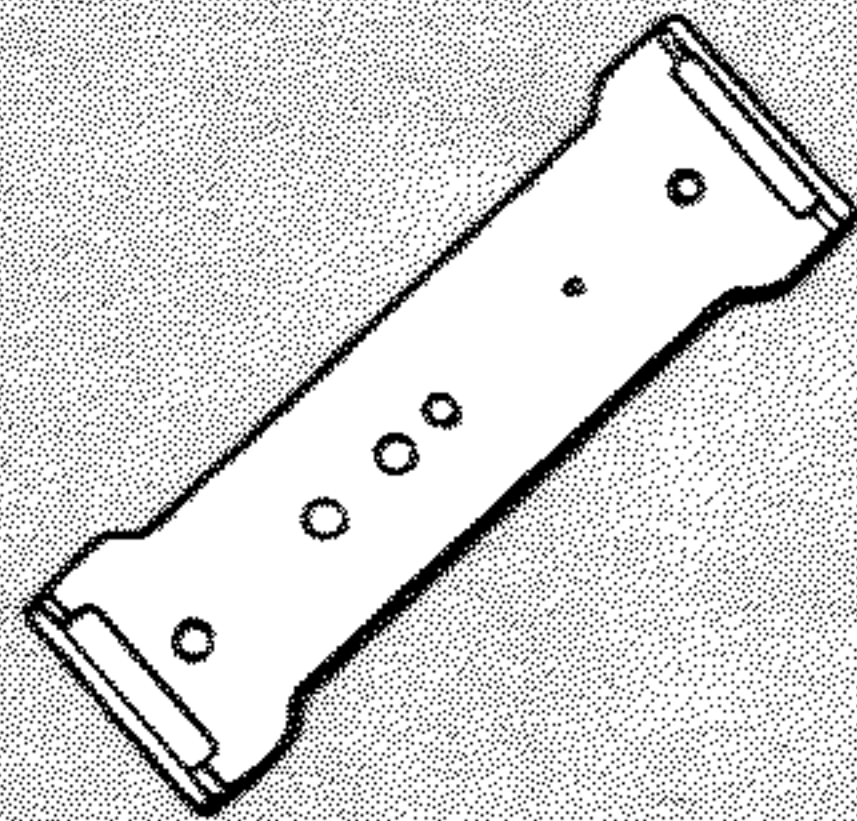
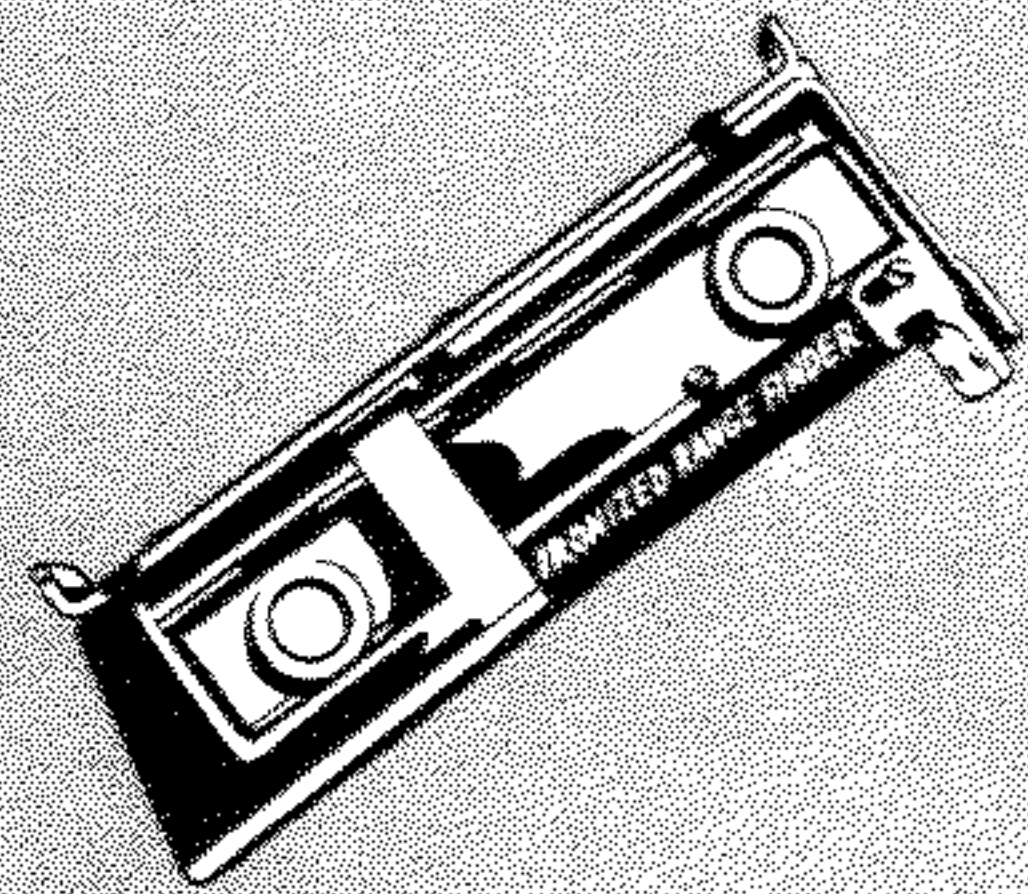



**TO ATTACH**—Slip the lower battery case clamp over the lug at the bottom of the mounting plate and swing the upper clamp against the top lug. A snap catch in the top bracket will hold the battery case firmly in place. To attach to Pacemaker handle lugs, first remove handle strap then proceed with the above instructions.

**TO REMOVE**—The release button will be found recessed in the top clamp. To remove simply press this button and swing the battery case outward.

**TO ADJUST CLAMPS**—Use a large screwdriver. An undersized or worn screwdriver will slip and burr the screw slots.

1. Back out the screw to allow the clamp to open far enough to move without binding on the tube.
2. Set the bottom clamp to engage the bottom mounting ear when battery case is nearly level with bottom of the camera.
3. Open the top clamp to allow it to move freely and slide it to approximate location of the bracket ear and tighten the screw slightly to remove slack. If necessary, straighten the latch spring in the top clamp with the screwdriver tip.
4. Press this clamp upward to remove vertical play and tighten all screws firmly.

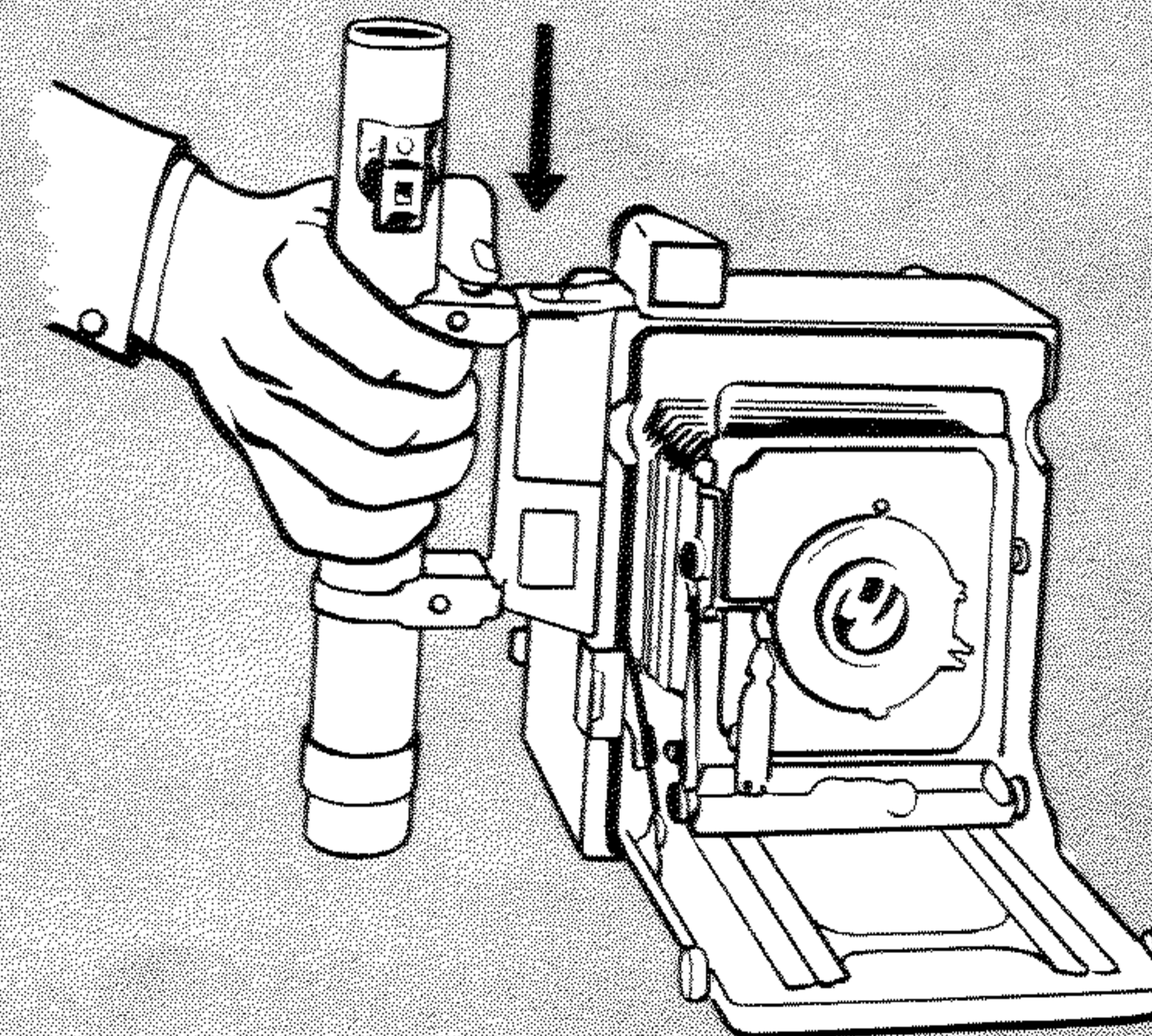
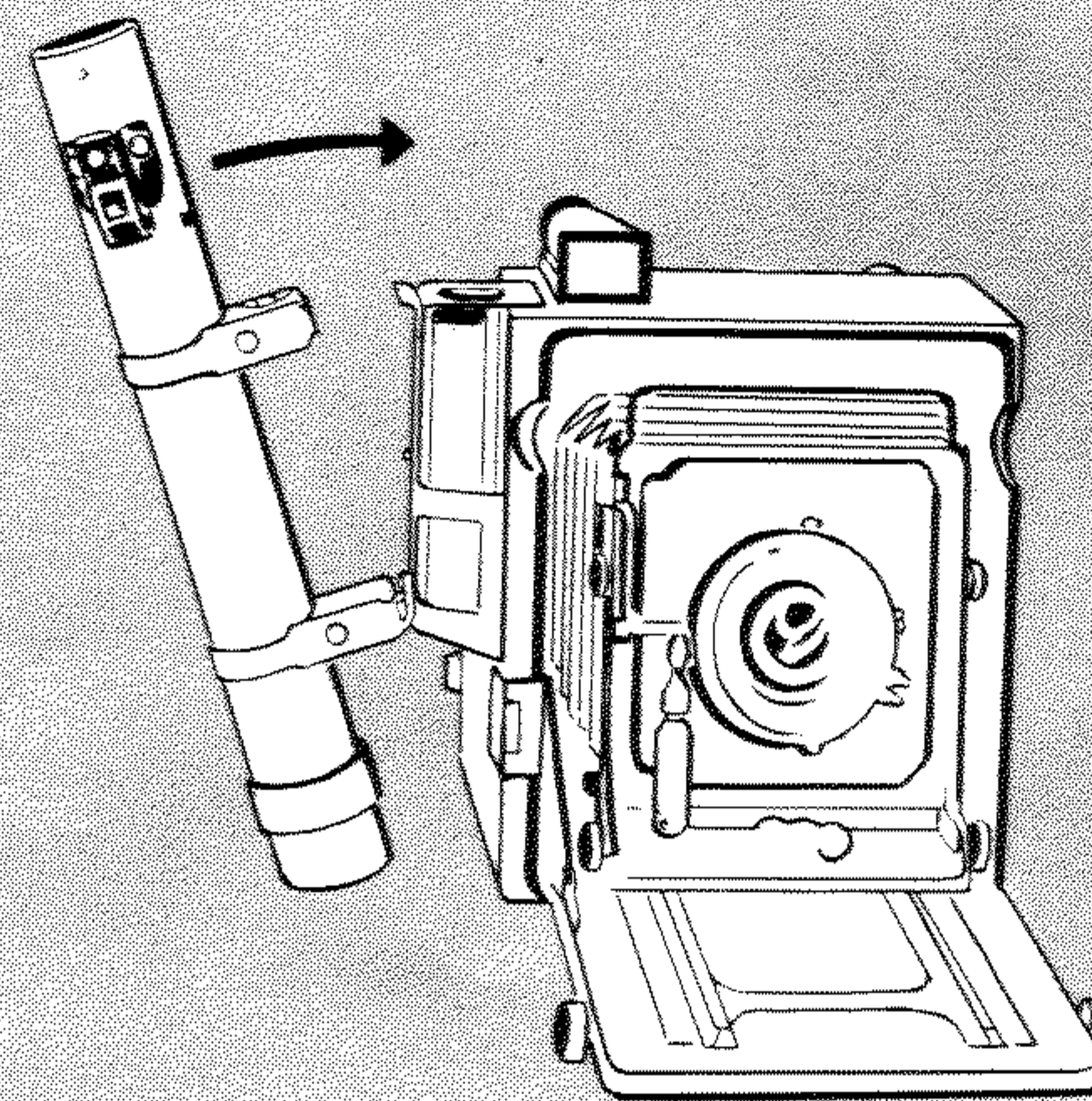





# REFLECTORS

## 7" REFLECTOR

This is designed for medium screw base lamps only such as the G-E 22 and 31 and the Sylvania Press

40 and 2A. To attach to battery case loosen the lock screw in the front of the base of the reflector assembly  and slip onto the battery case. The reflector will center itself as the guide screw in the battery case engages in the "V" slot in the reflector base. Tighten the lock nut to hold the reflector in place. The reflector may be adjusted to flash lamp heights by means of the lock nut at the rear of the reflector. 

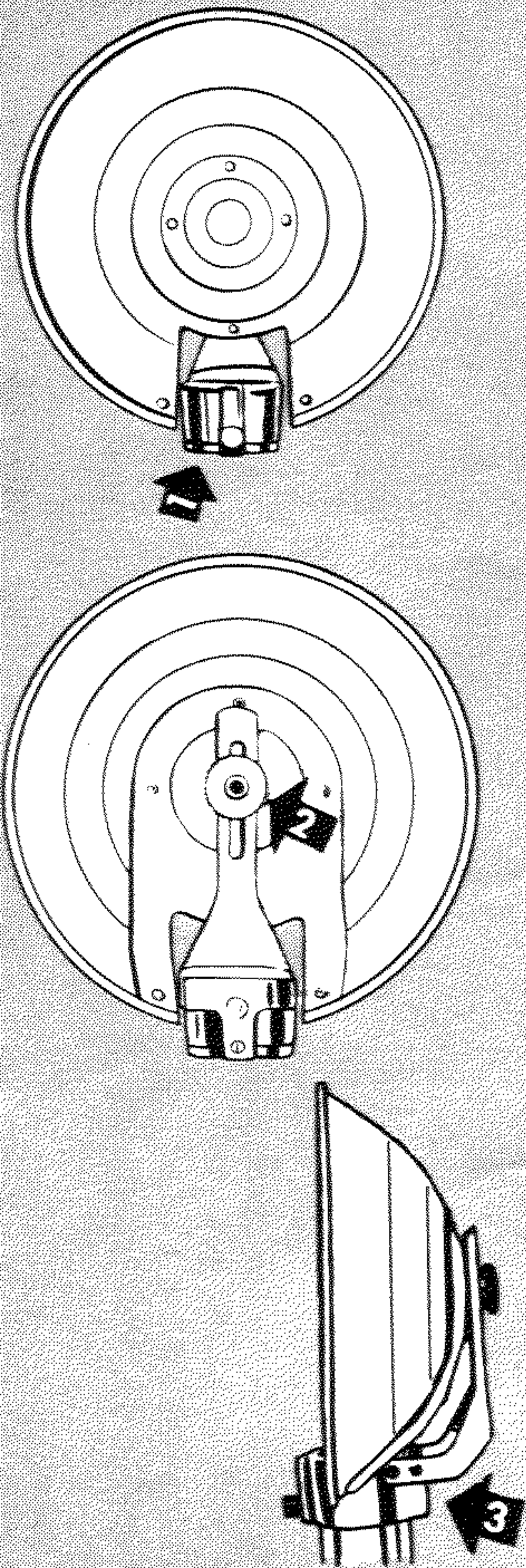

Burned out lamps are removed by pressing the ejector button at the back of the reflector base.  The sharp pointed spring loaded center contact will assure positive lamp contact and more dependable performance regardless of the condition of the solder at the base of the lamps being used.





## **INTERCHANGEABLE ON ALL GRAFLITE BATTERY CASES**

### **5" REFLECTOR**

This reflector is designed for bayonet base lamps only such as the Sylvania SF and Press 25 and the General Electric SM and No. 5. It is the only reflector design providing maximum, even distribution of the light output of the small lamps over a field of  $60^\circ$ , which corresponds to that included by most camera and lens combinations. To attach to battery case loosen the lock nut in the front of the base of the reflector assembly  and slip onto the battery case head. The reflector will center itself as the guide screw in the battery case engages in the "V" slot in the reflector base. Tighten the lock screw to hold the reflector in place. The reflector may be adjusted for spot focusing by loosening the lock nut at the top of the reflector head  and moving the reflector forward. Bayonet base lamps are inserted in the socket with a simple right hand or clockwise twist which will cause them to spiral into place. Eject the burned out lamps by pressing the ejector button at the back of the reflector base.  The sharp pointed spring loaded center contact will assure positive lamp contact and more dependable performance regardless of the condition of the solder at the base of the lamps being used.

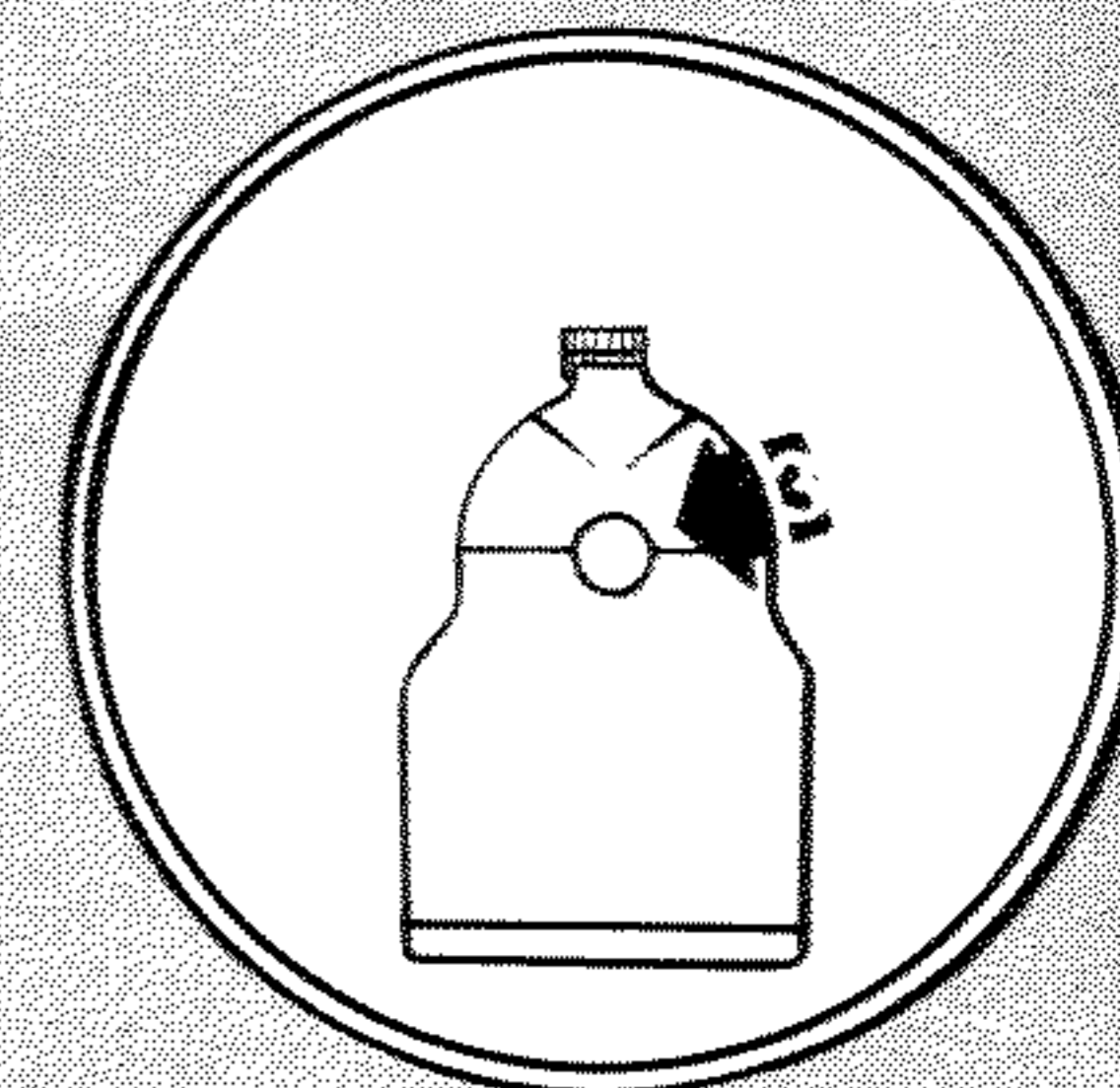
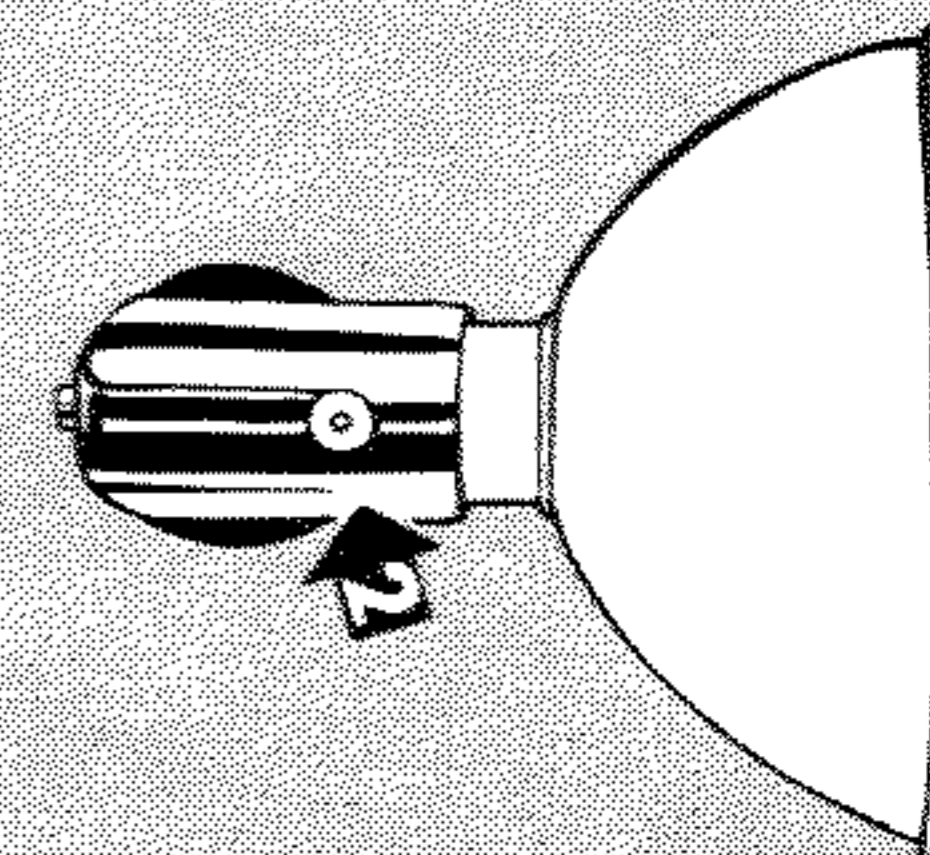
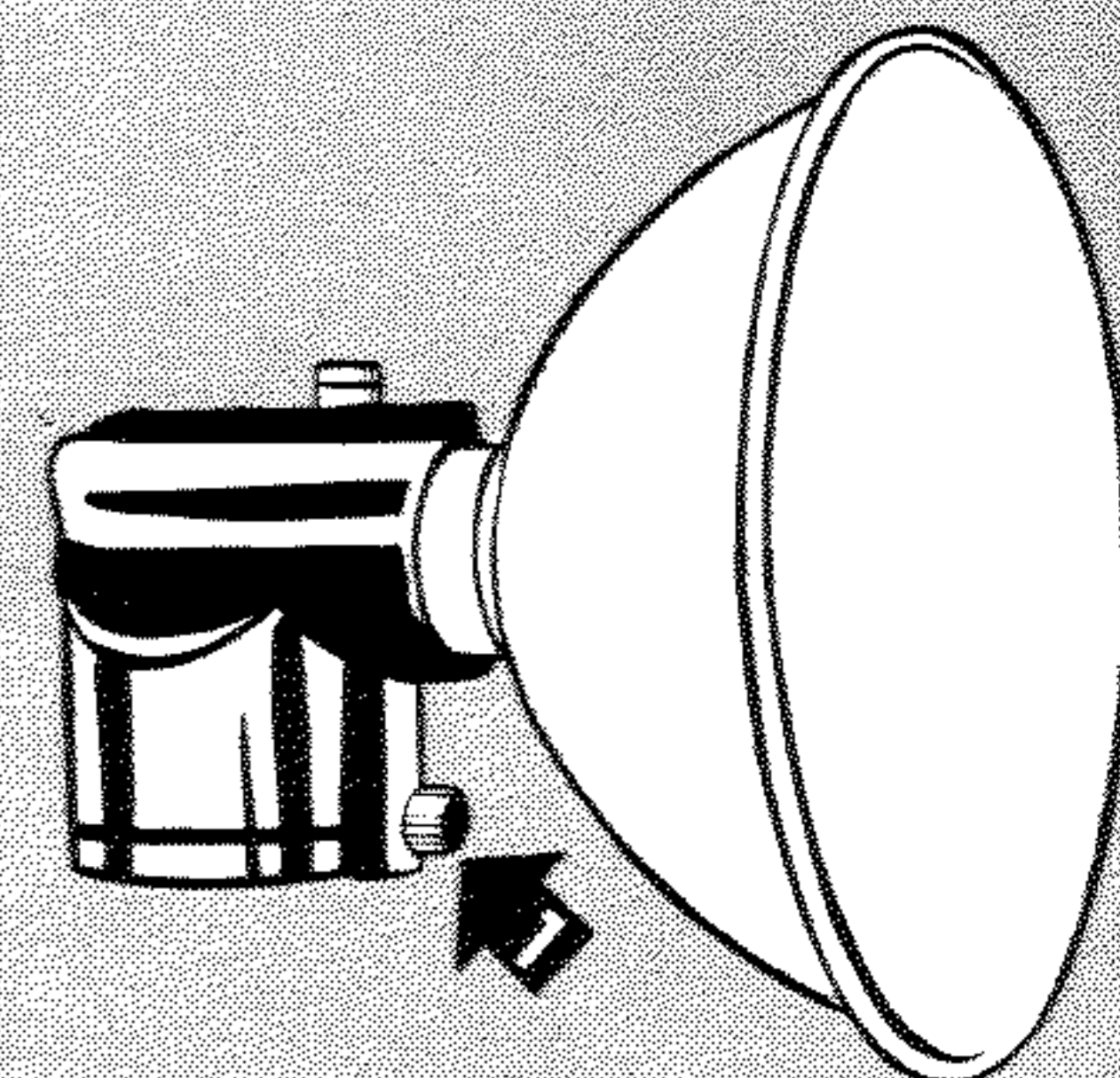



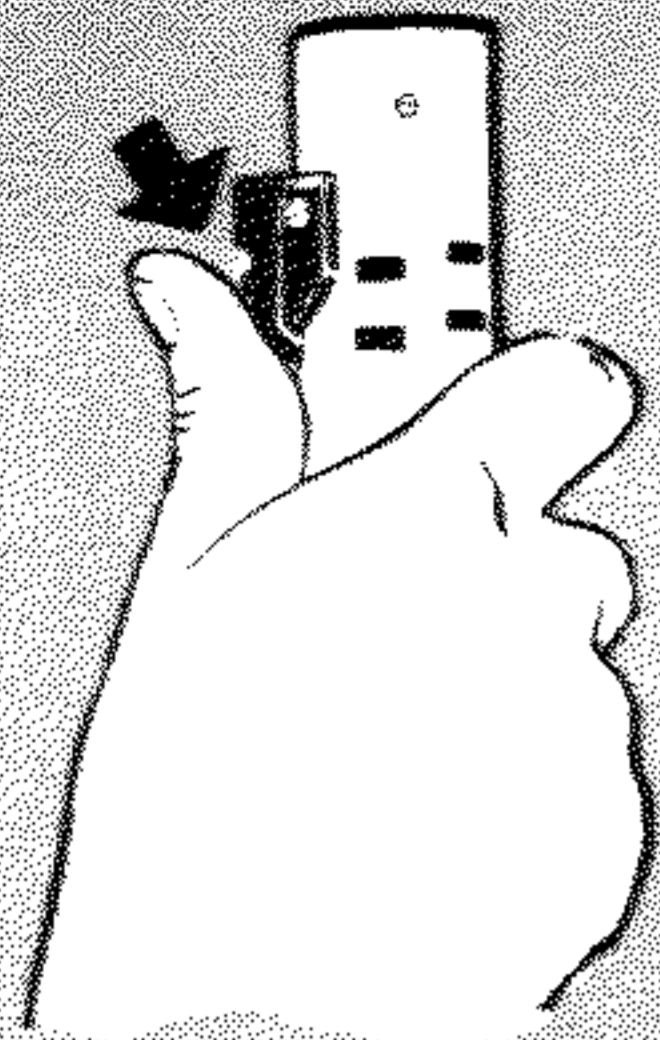

**PUSH or PULL**

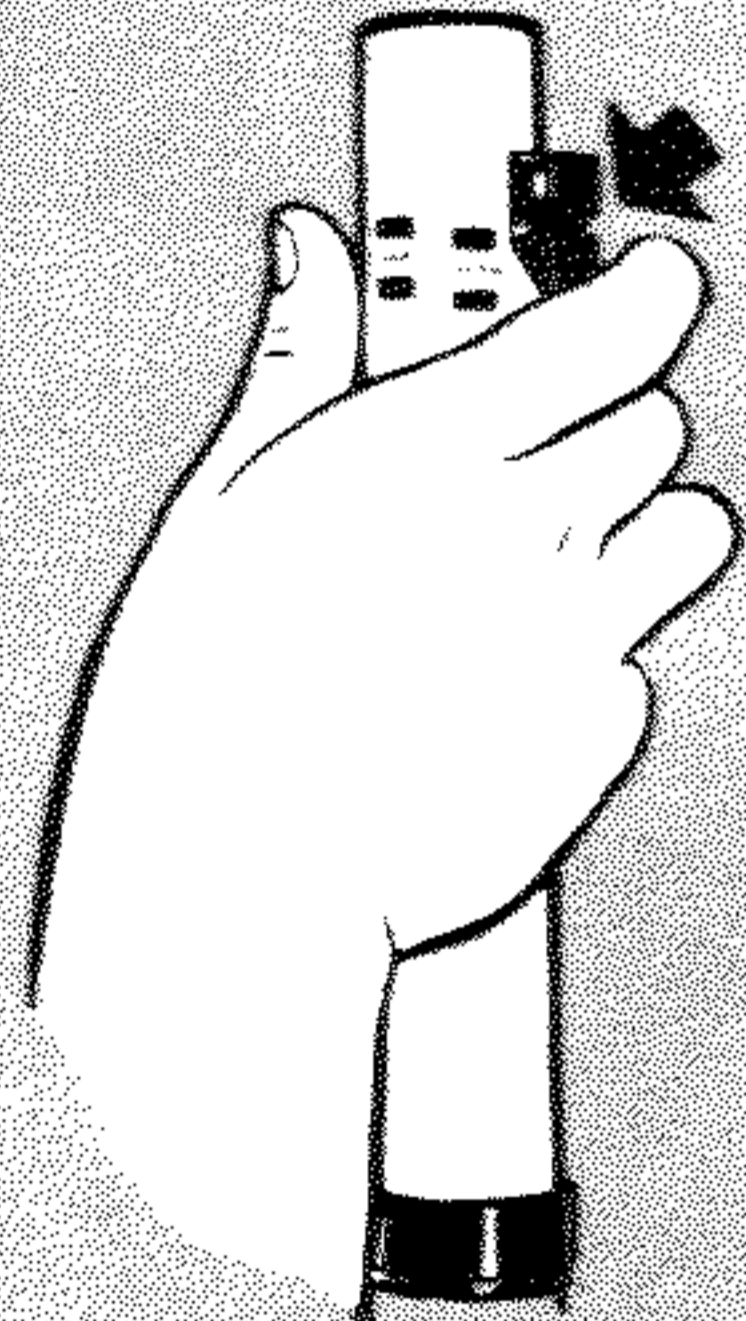

  
**CHECK**

After the main switch has been located either to the front or rear of the battery case, by simply loosening and repositioning the battery case clamps, care should be taken to see that the medium base lamp socket assembly is also properly located. The small con-

tact tip in the battery case (that contacts the lock screw in the reflector base) must always appear at the front of the battery case so that medium base

lamps can be ejected, and contact made with the 5" reflector.

To relocate this contact tip (if necessary) remove the reflector guide screw located at the top side of the battery case. Lift the black socket with ring free of the battery case. Revolve rubber washer in base of battery case socket. Holding the ring and contact spring in their respective recesses in the removed socket, revolve the unit to the correct position (contact spring to the front) and replace making sure the contact tip protrudes through the lower hole in the battery case. Replace the reflector guide screw.

---

If you have a GRAFLITE synchronizer your solenoid should be installed by a competent camera mechanic with adequate testing facilities. Remember—increasing or decreasing the number of batteries in your battery case will affect the synchronization of the solenoid and necessitate resynchronization. For good, dependable results your batteries should test at *least* 7 amps. Check your batteries regularly.

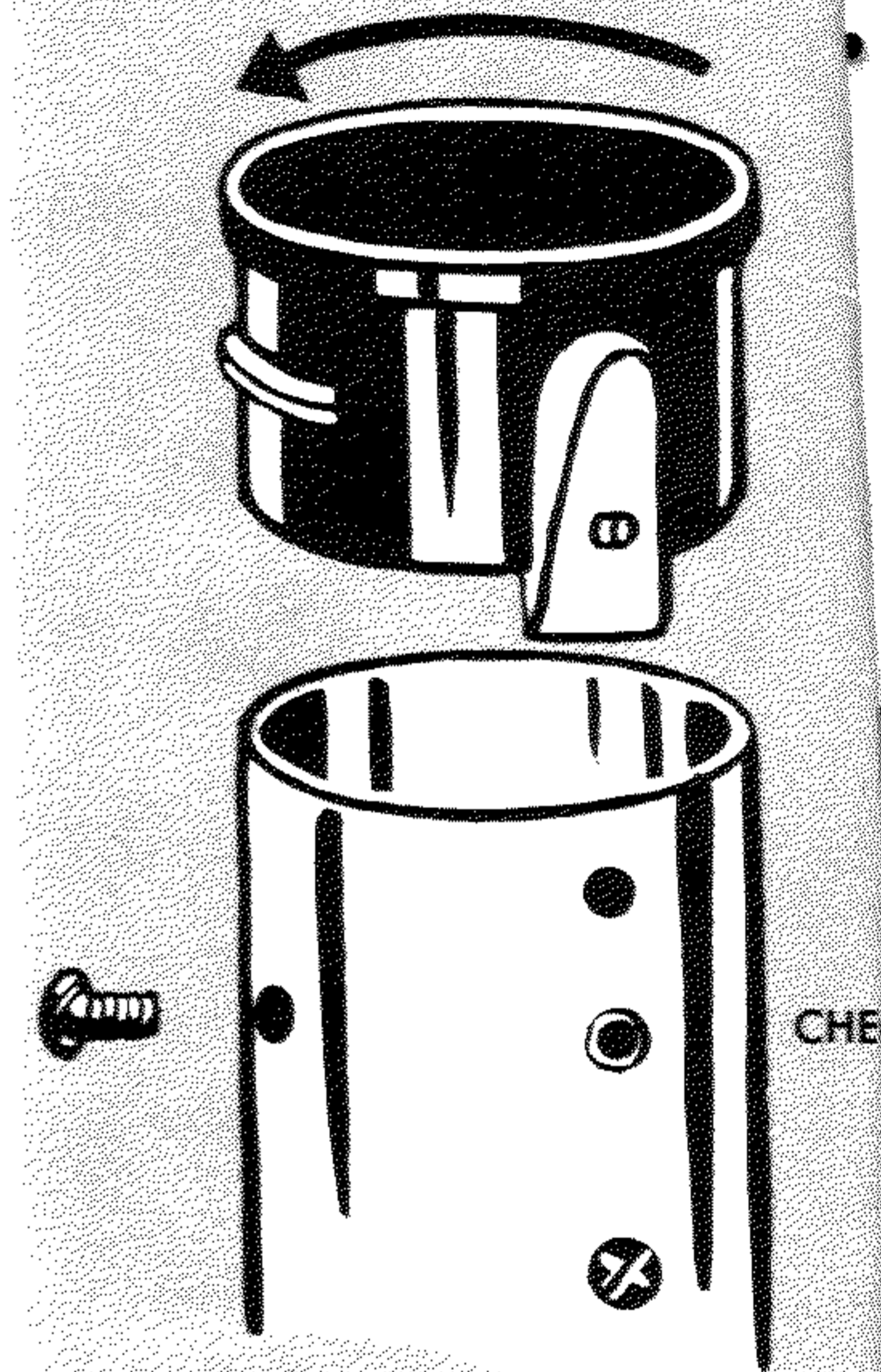



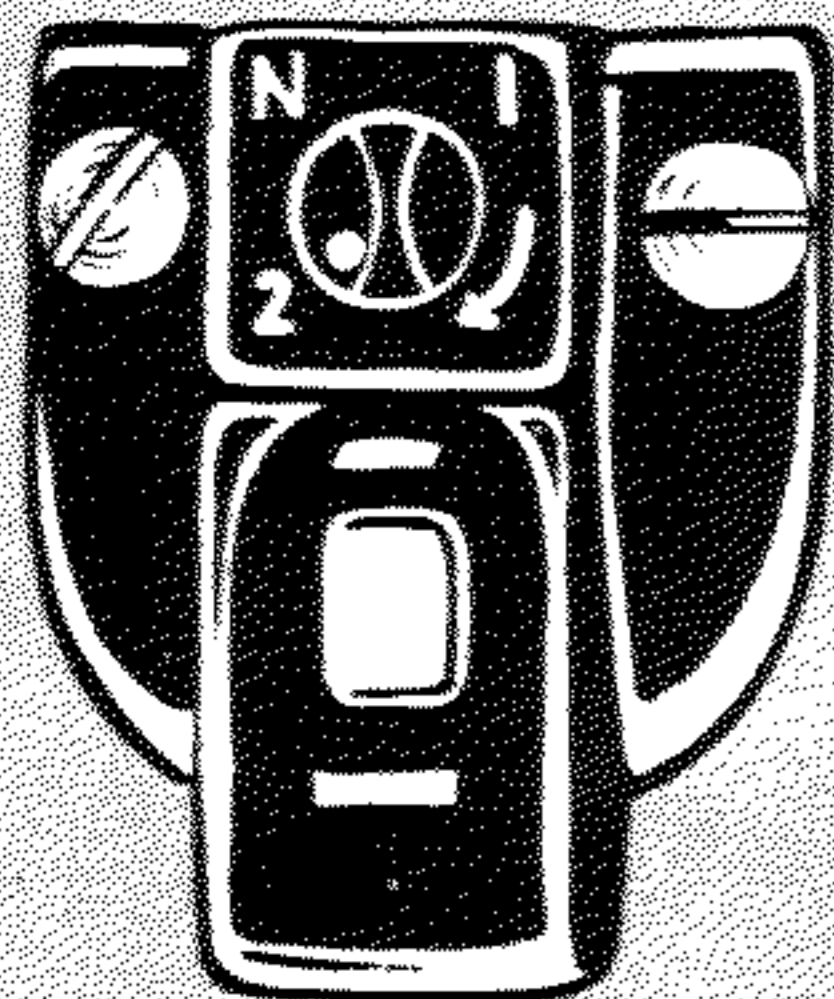

## **CIRCUIT CONTROL**

The switch assembly includes a multi-purpose circuit controller. This provides many useful circuit combinations described in this manual that will prove helpful to you. You will find one of the prongs on your connecting cord useful in turning this controller.

## **OUTLETS and PLUGS**

The GRAFLITE battery case has five outlets. They are identified for normal use as follows—

1. **EXTENSION**—For use with extension cords.
2. **SHUTTER**—To be connected with contact posts of built-in synchronized shutter. (Front or Focal Plane) Do not attach to contact posts of an (x) type shutter.
3. **BATTERY**—A "HOT" or open outlet not controlled by main switch. Plug Focuspot or Focalite into this outlet.
4. **REMOTE**—For operating equipment with remote control cord.
5. **SOLENOID**—To be connected with solenoid operating the front between-the-lens shutter.

**PLUGS**—GRAFLITE connecting cords are available in different lengths and styles. Emergency or special cords can be made using No. 18 copper stranded wire and standard household plugs. All connections should be soldered and contacts clean. To avoid damage to contact springs in battery case use only plugs with solid type rounded end contact posts. To maintain polarity always insert plugs with cord running down. Polarity must also be maintained when special cords are used.

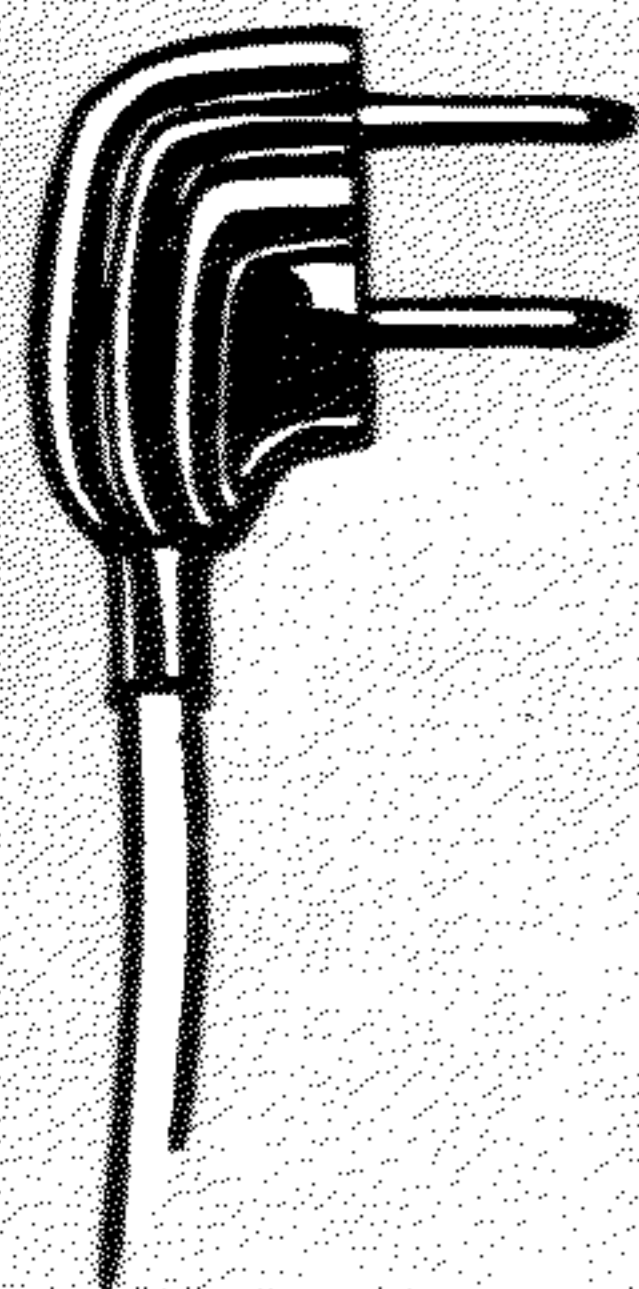

NORMAL

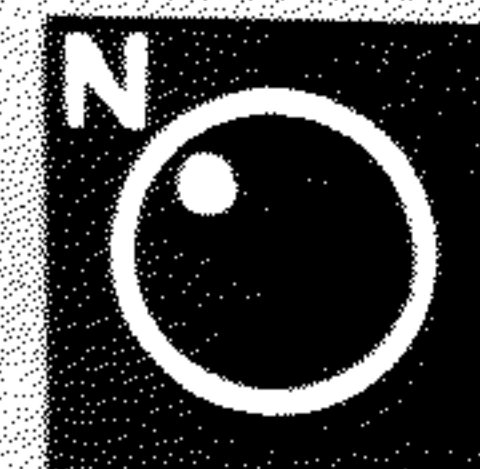

ELECTROSWITCH



TWO-BATTERY  
CASES

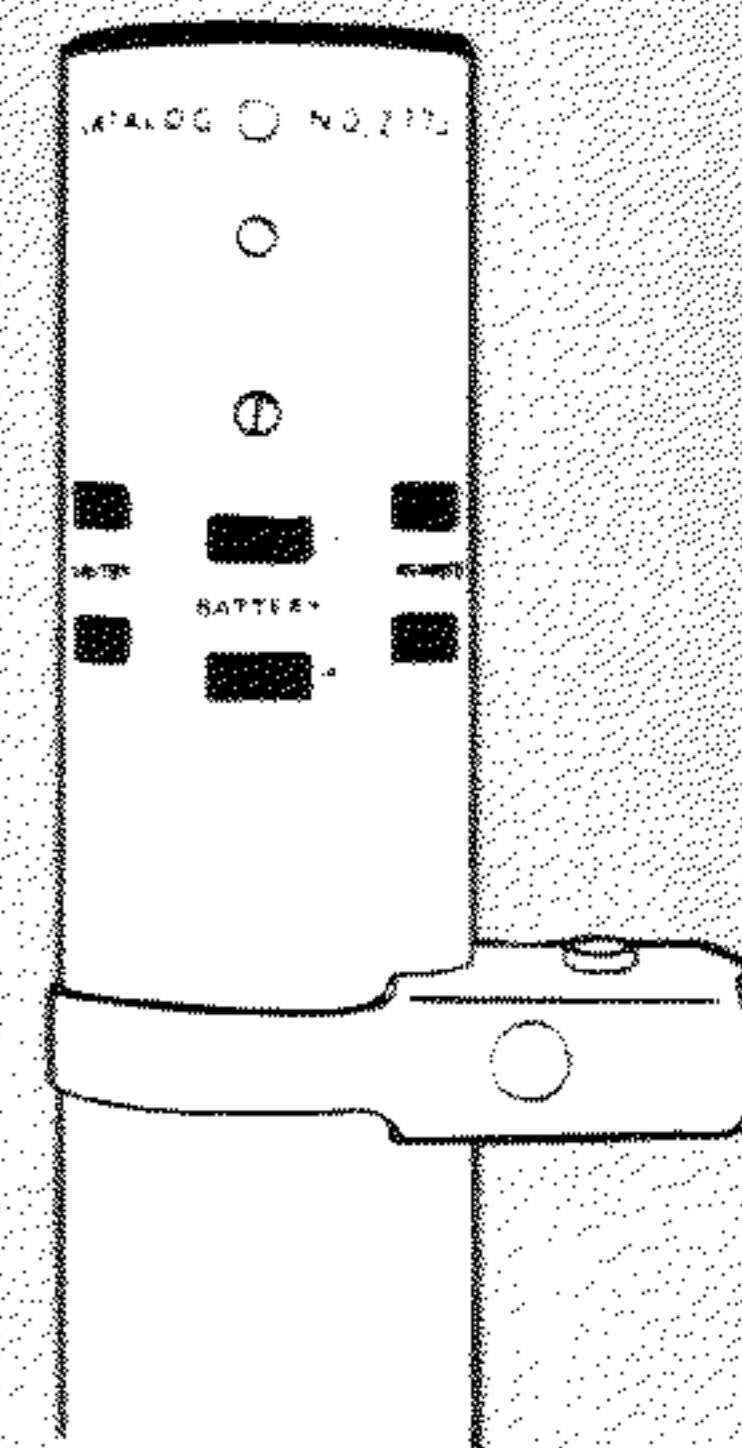



# BASIC (Single Battery Case)

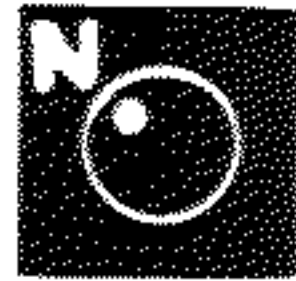

## SOLENOID

Connect solenoid release with **SOLENOID** outlet using a 17" or 36" solenoid cord and set circuit controller as shown. *To operate*, press main switch on battery case or press switch on remote control cord attached to **REMOTE** outlet.

Attach extension cord to **EXTENSION** outlet.

Do not attach extension cords to **SHUTTER**, **REMOTE**, or **BATTERY** Outlets, since they are hot and will fire lamps as they are placed in socket.

When additional power is needed for extensions, extension tubes may be added, but solenoid must be readjusted as indicated on page 19. With synchronized shutters, be sure sync. control lever is in "OFF" position.



## SYNCHRONIZED FRONT SHUTTER

Connect contact posts on shutter to **SHUTTER** outlet on battery case with 20" or 36" shutter cord and set circuit controller as shown.

*To operate*, trip release lever of synchronized shutter. Be sure to have shutter set for the time lag required by the lamps being used. Extension cords can be attached to the **EXTENSION** and **SOLENOID** outlets.

Do not attach extension cords to **REMOTE** or **BATTERY** outlets since they will be hot at all times. When additional power is needed for extensions, add extension tubes.

To eliminate the danger of accidentally firing the flash lamp by pressing the main switch, turn the circuit control to the #1 position. In this position, the solenoid outlet may not be used for extension cords.

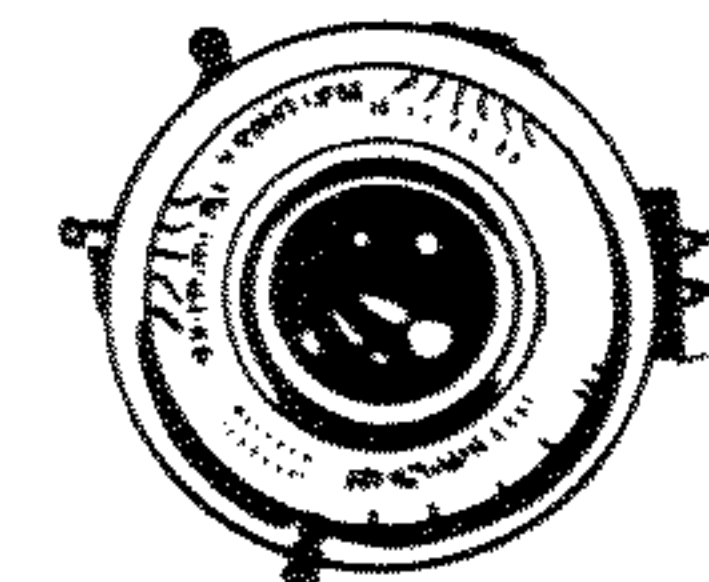



# C O N N E C T I O N S \* \*



## SYNCHRONIZED FOCAL PLANE SHUTTER

Connect contact posts on shutter to **SHUTTER** outlet on battery case with 20" or 36" shutter cord and set circuit controller as shown.

*To operate*, trip focal plane shutter release. **CAUTION:** Be sure to use correct lamps for this shutter as specified in the camera manuals.

Extension cords can be attached to the **EXTENSION** and **SOLENOID** outlets.

Do not attach extension cords to **REMOTE** or **BATTERY** outlets since they will be hot at all times. When additional power is needed for extensions, add extension tubes.

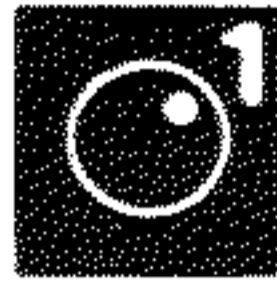
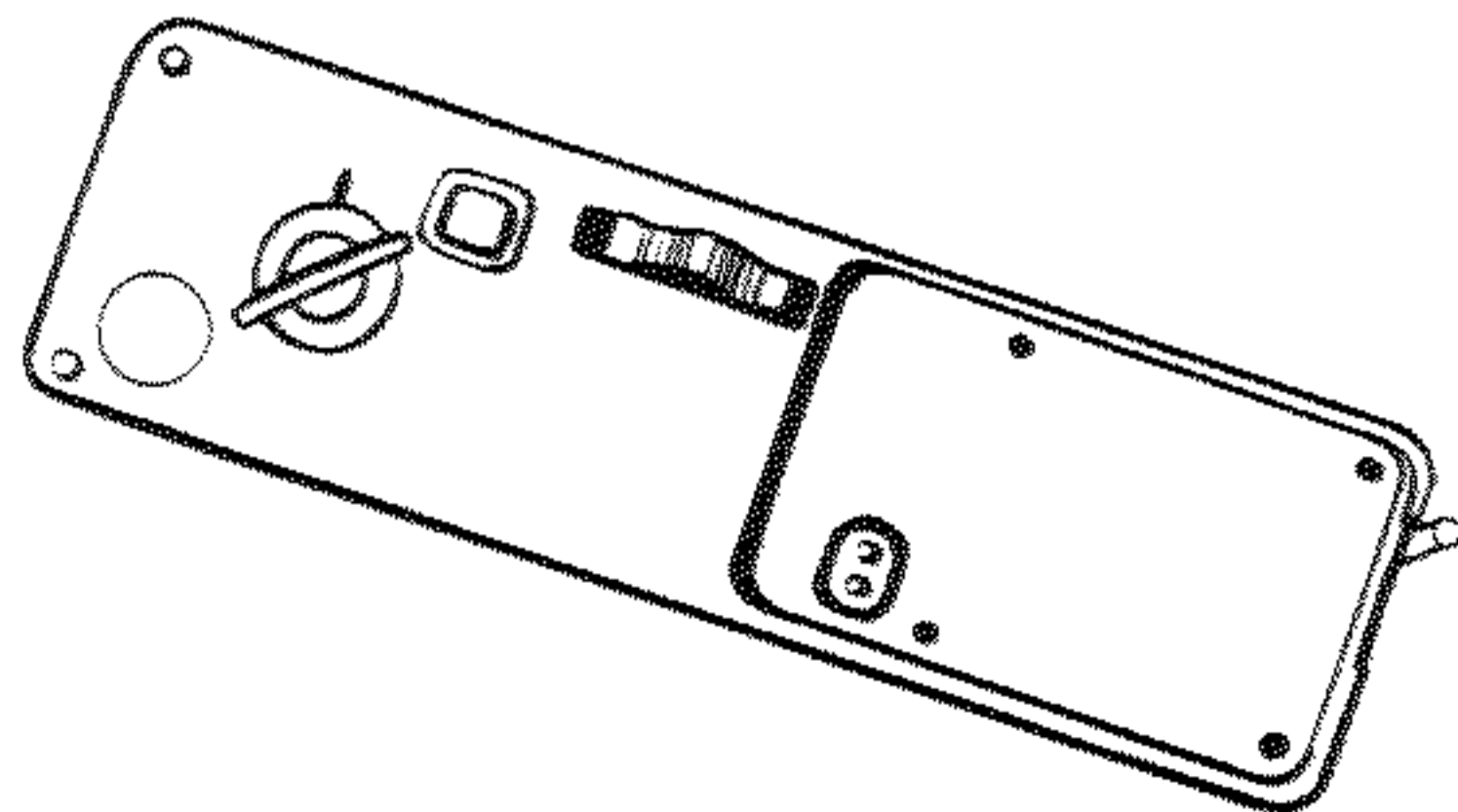

## ELECTROSWITCH SOLENOID WITH SYNCHRONIZED SHUTTER

Connect solenoid release with **SOLENOID** outlet using a solenoid cord and connect synchronized shutter with **SHUTTER** outlet on battery case, using a shutter cord and set circuit controller as shown.

*To operate*, set controls of synchronized shutter and press main switch on battery case or switch on remote control cord attached to **REMOTE** outlet. When additional power is needed for extensions, add extension tubes. Extension cord can be attached to the **EXTENSION** outlet.

Do not attach extension cords to **REMOTE** and **BATTERY** outlets, since they will be hot at all times.

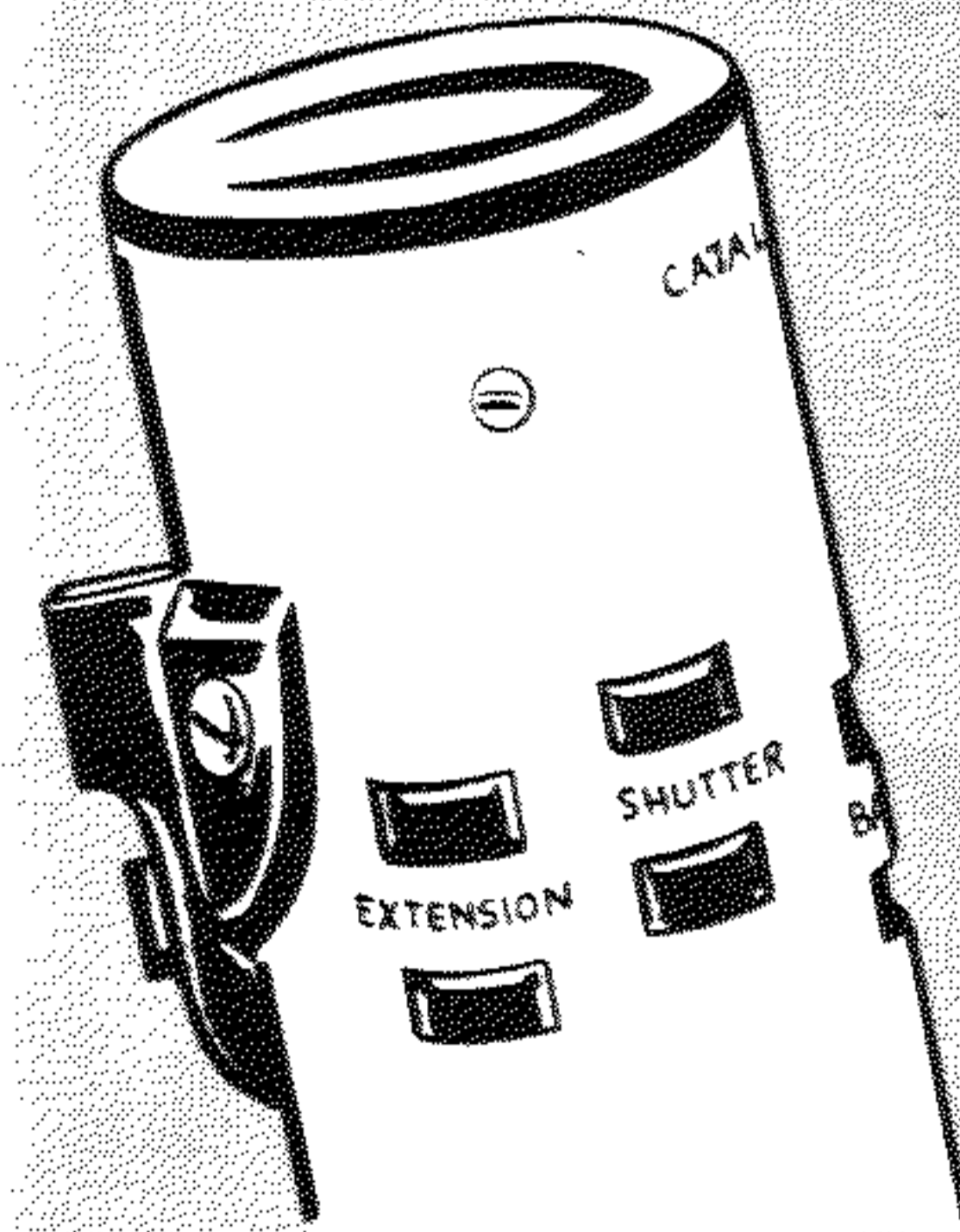
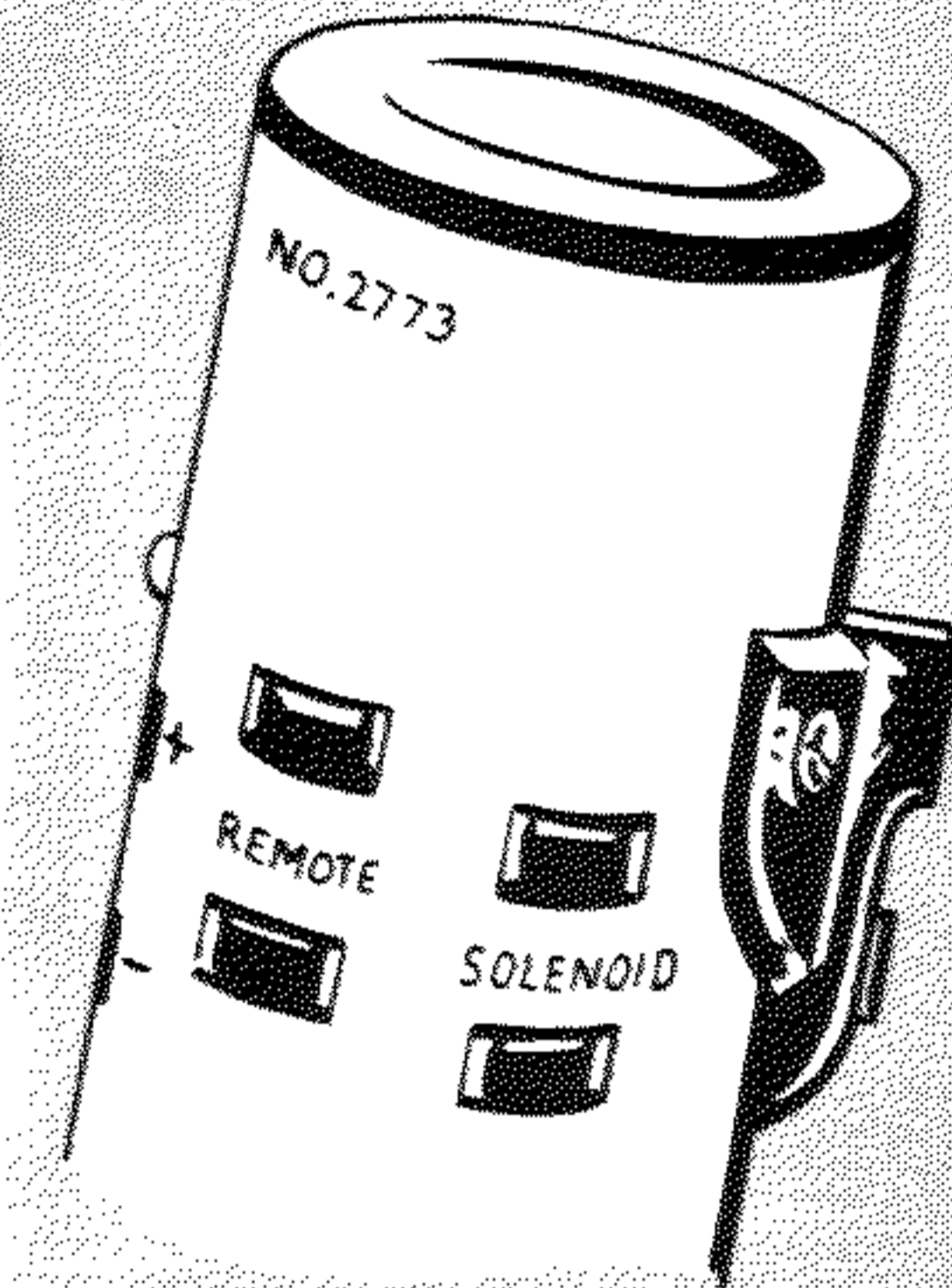
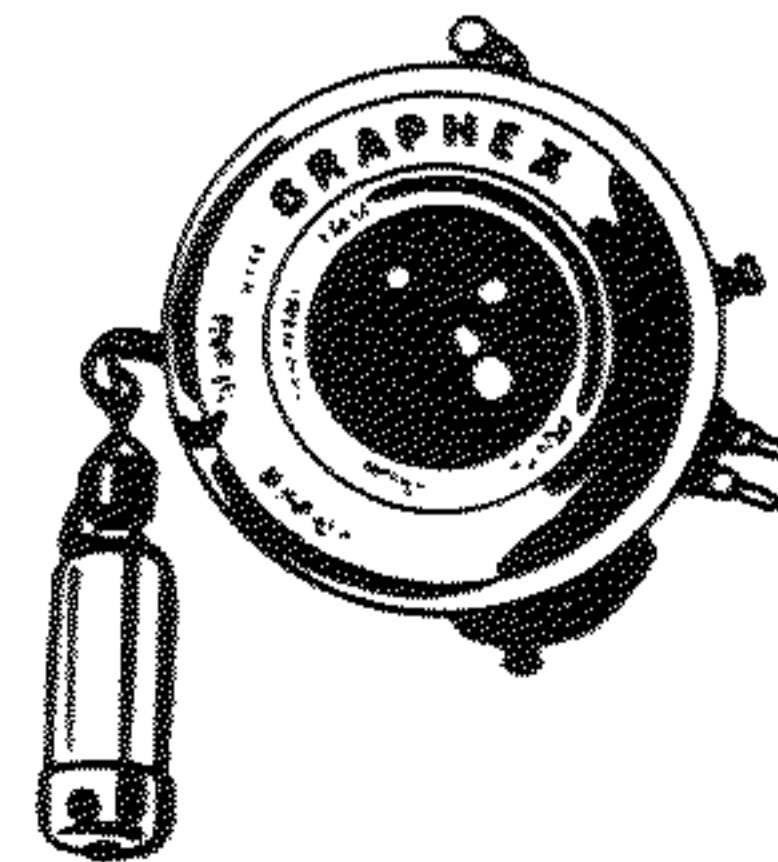



# SPECIAL (Dual Battery Case) CONNECTIONS

## WHY

The many outlets and the three different electrical circuits possible in the GRAFLITE battery cases make many special battery case combinations and connections possible. Only the following are of value, since others, (a) may not provide as many useful outlets, (b) will utilize the batteries in only one battery case, (c) may short the batteries directly or (d) may produce hot or live lamp sockets independent of the switches.

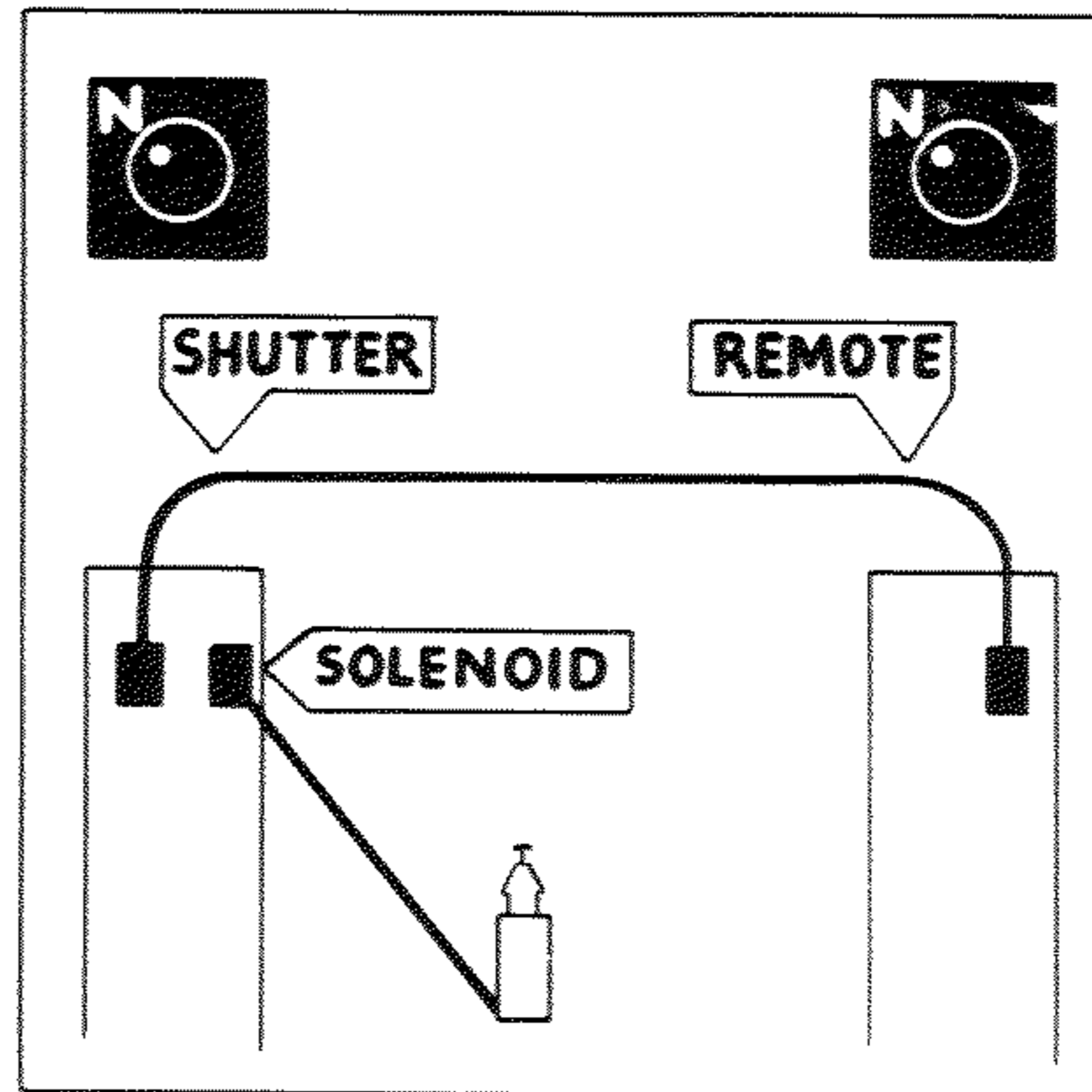

## SOLENOID

Connect battery cases with 16" connector cord and solenoid release to **SOLENOID** outlet with solenoid cord and set circuit controls as shown above. *To operate*, press either main switch on either battery case or switch on remote control cord attached to any **SHUTTER** or **REMOTE** outlet. Attach extension cords to any open **EXTENSION** or **SOLENOID** outlet. Do not connect extension cords to remaining **REMOTE**, **SHUTTER** and **BATTERY** outlets since they are hot and will fire lamps on contact. If extension tubes are used add equally to each battery case.

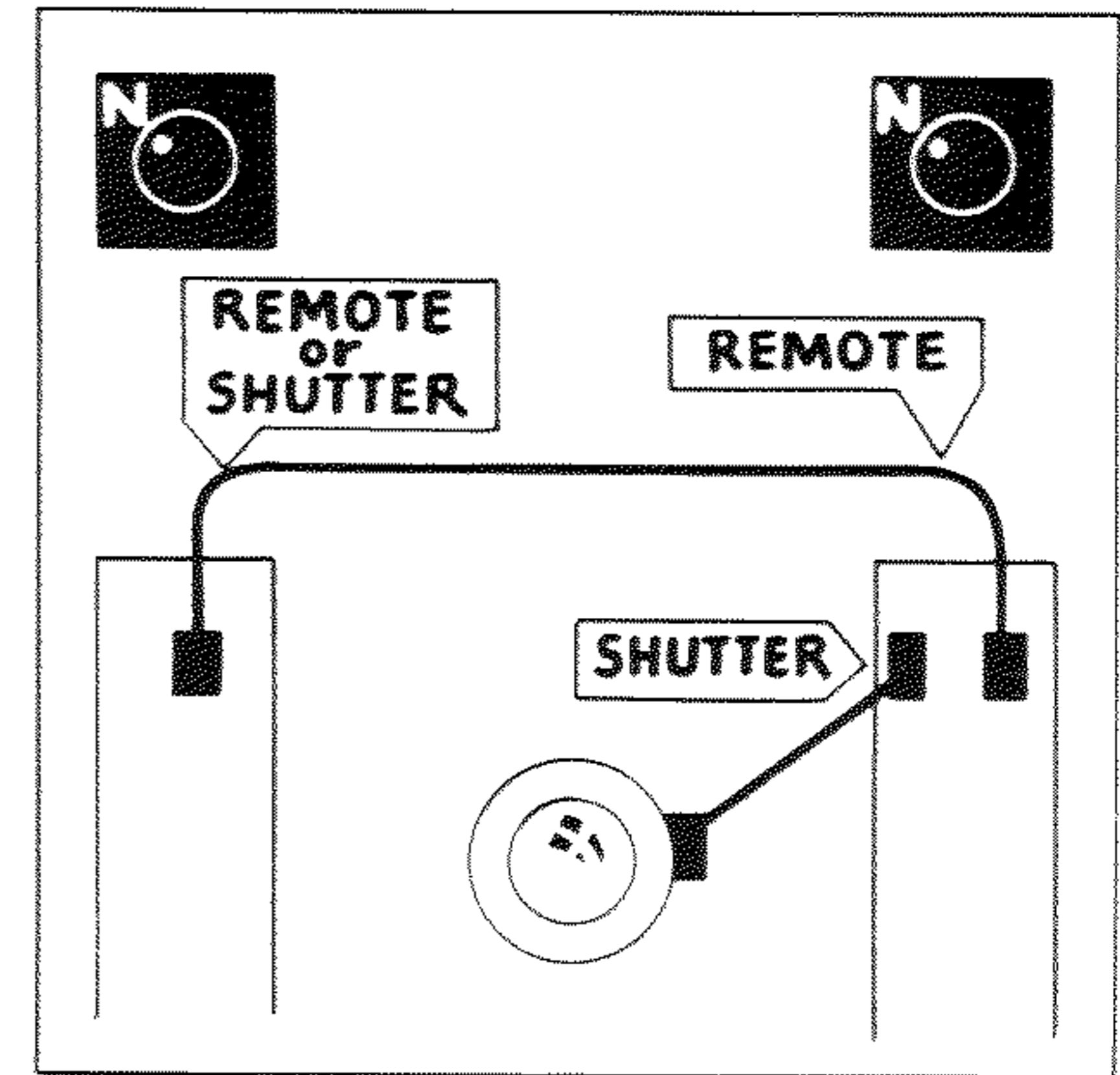

## SYNCHRONIZED SHUTTER

Connect battery cases with 16" connector cord and synchronized shutter to **SHUTTER** or **REMOTE** outlet with shutter cord and set circuit controls as shown above.

*To operate*, press release of synchronized shutter.

Attach extension cords to any open **EXTENSION** or **SOLENOID** outlet. Do not connect extension cords to remaining **REMOTE**, **SHUTTER** and **BATTERY** outlets since they are hot and will fire lamps on contact.

## IF

If the GRAFLITE owner wishes to experiment with connections other than those recommended herewith, he should use test lamps in all sockets and test all connections with a volt meter before attempting to use any flash lamps. Note that there is no voltage increase to be obtained by connecting the two **BATTERY** outlets, and this connection may only exhaust the batteries.



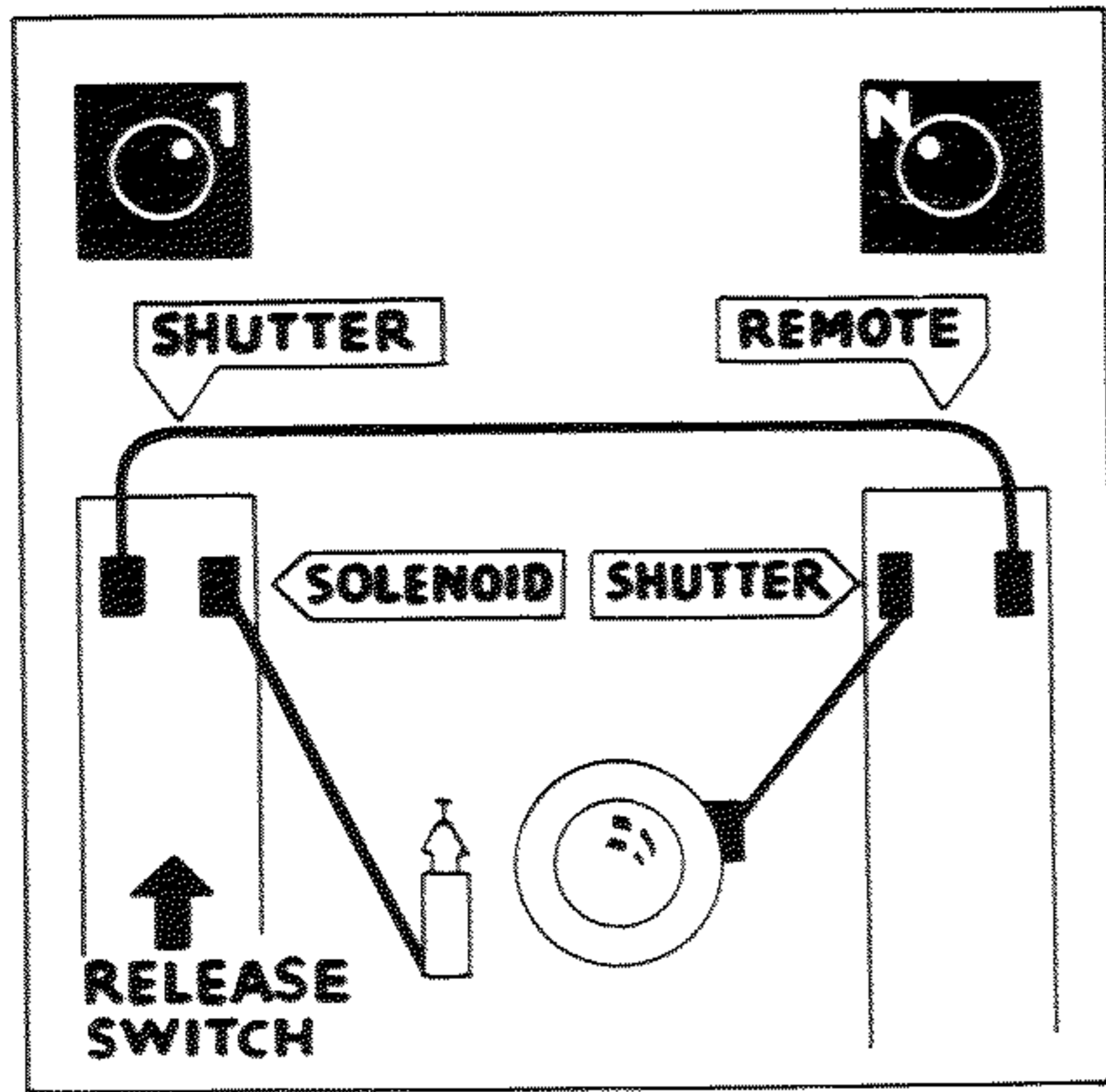

### ELECTROSWITCH

Connect battery cases with 16" connector cord and synchronized shutter to **S H U T T E R** outlet with shutter cord and solenoid release to **SOLENOID** outlet with solenoid cord and set circuit controls as shown. *To operate*, set synchronized shutter. Press main switch on battery case or remote switch attached to **REMOTE** outlet on battery case set at "1". Extension cords can be attached to any **EXTENSION** or the remaining **SOLENOID** outlet. Do not connect extension cords to **REMOTE** or **BATTERY** outlets. Do not use extension tubes.

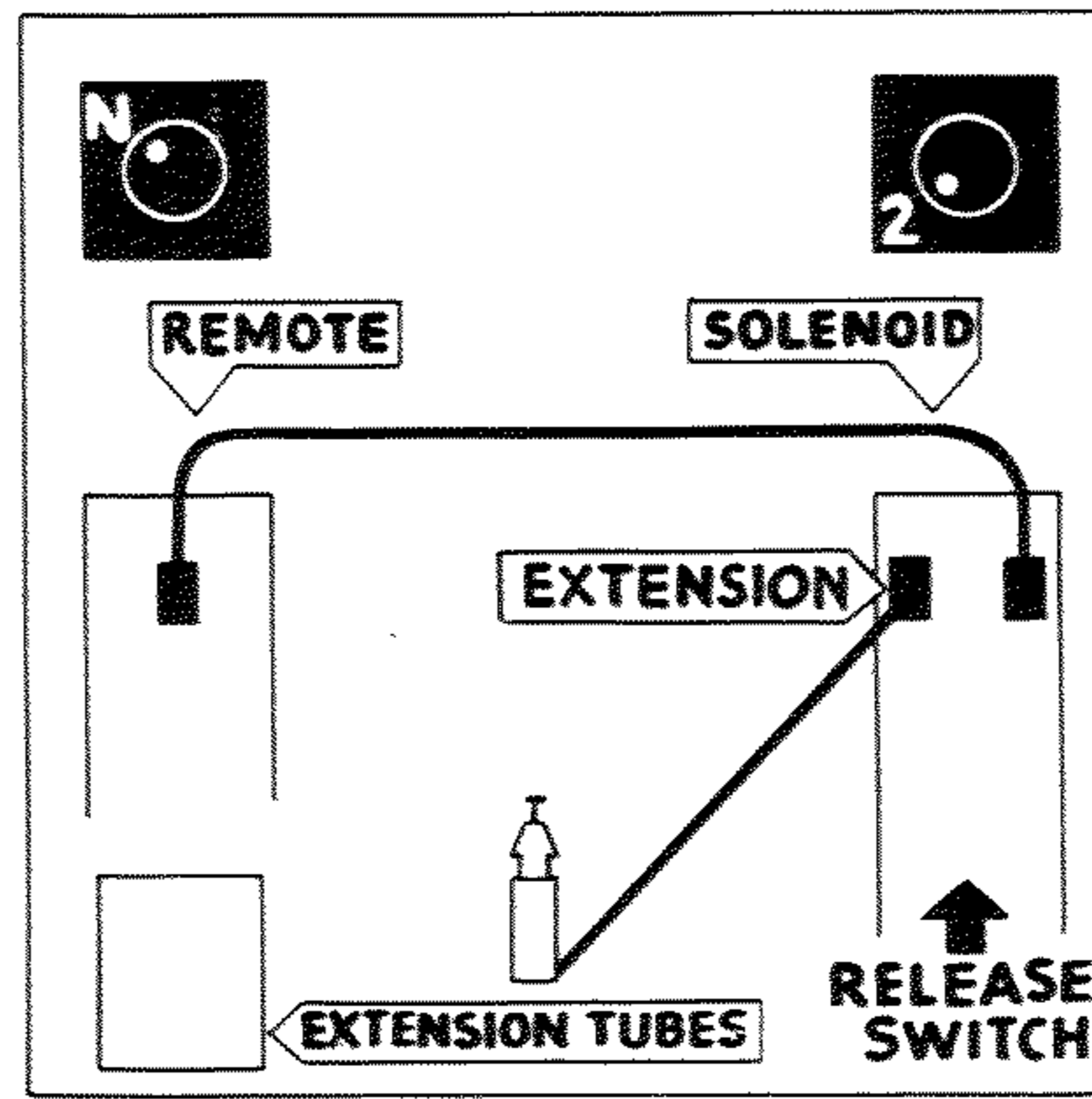

## Combined Power for Long Extensions

### EXTENSION TUBES

Extension Tubes may be added if desired to battery case set at "N" for more power. Connect battery cases with 16" connector cord and solenoid release to **EXTENSION** outlet with solenoid cord and set circuit controls as shown. *To operate*, press switch at battery case set at "2". Extension cords can be added to remaining **SOLENOID** and **EXTENSION** outlets. They will flash with combined power of both battery cases. Do not attach extension cords to **SHUTTER**, **BATTERY** or **REMOTE** outlets.

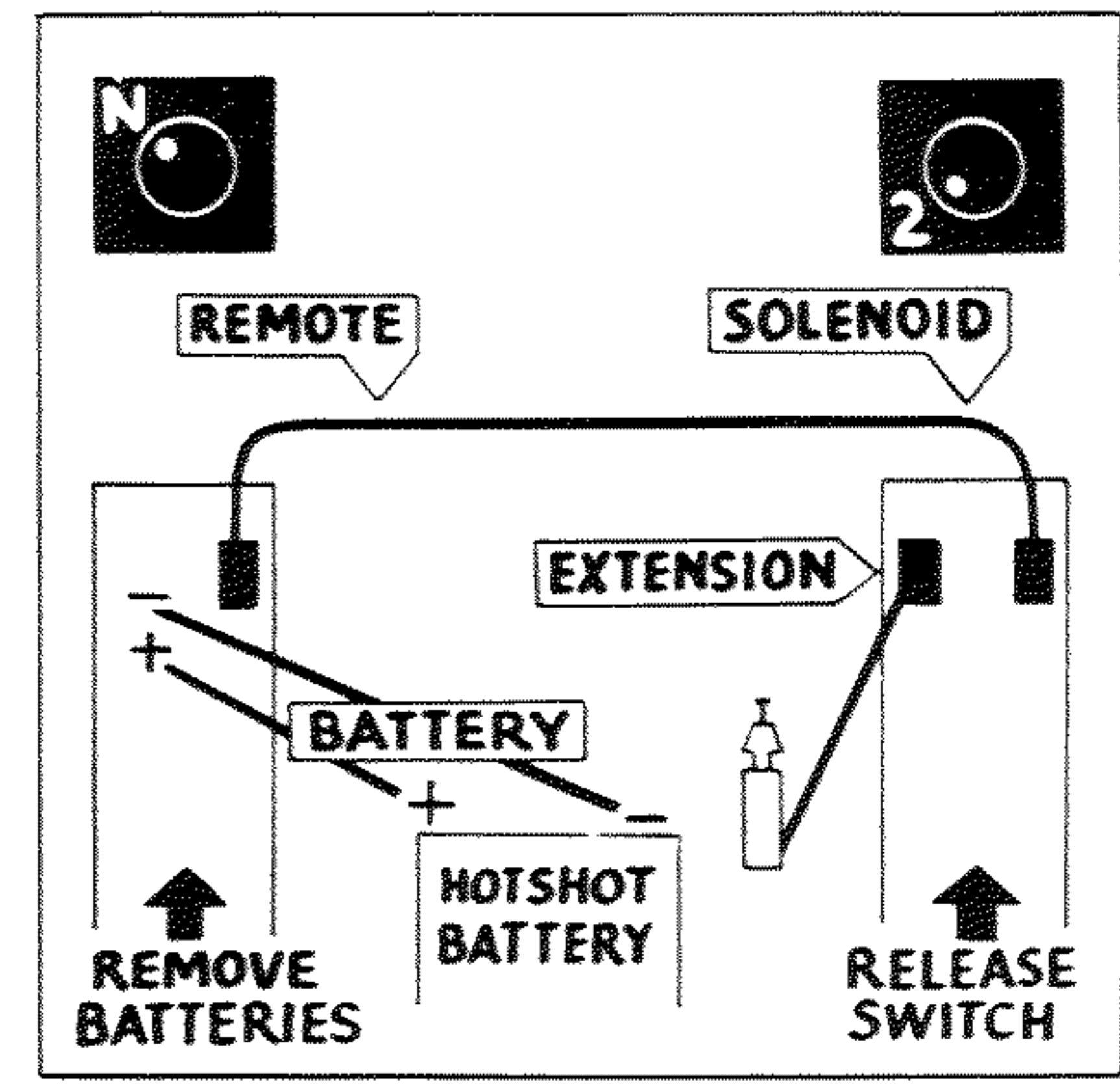

### HOT SHOT BATTERY

Connect battery cases with 16" connector cord and solenoid release to **EXTENSION** outlet with solenoid cord and set circuit controls as shown. Remove batteries from battery case set at "N". Maintaining polarity (+ to +), connect booster battery to **BATTERY** outlet of battery case set at "N". *To operate*, press switch on battery case set at "2". Extension cords can be attached to the remaining **SOLENOID** and **EXTENSION** outlets. They will be flashed with combined power of all batteries. Do not attach extension cords to **SHUTTER**, **BATTERY** or **REMOTE** outlets.



# CONNECTING CORDS

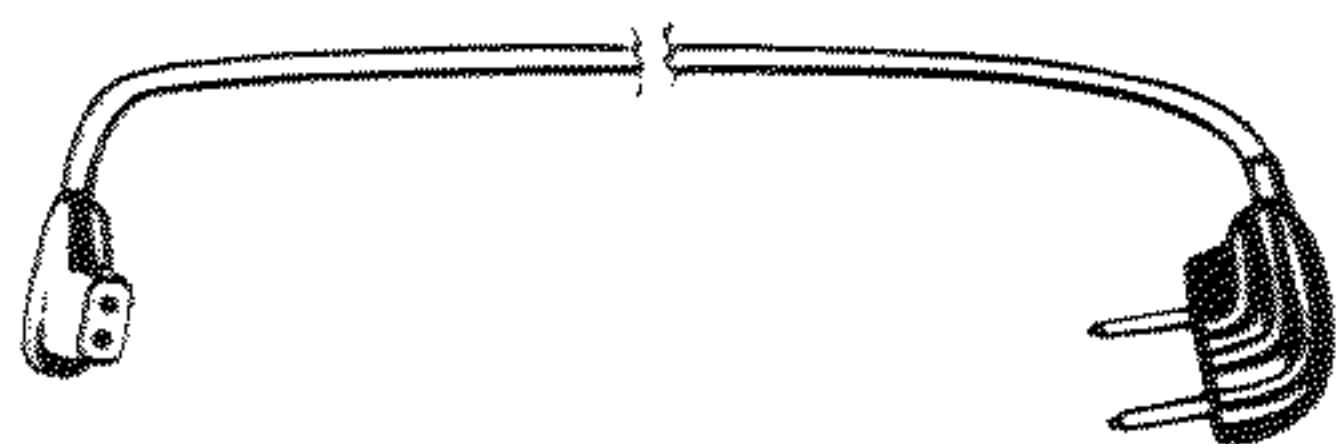

**SHUTTER CORDS**  
Synchronized shutter to  
**SHUTTER** Outlet

Cat. No.	Length
2701	20"
2702	36"



**SOLENOID CORDS**  
Solenoid to **SOLENOID**  
Outlet

Cat. No.	Length
2703	17"
2704	36"

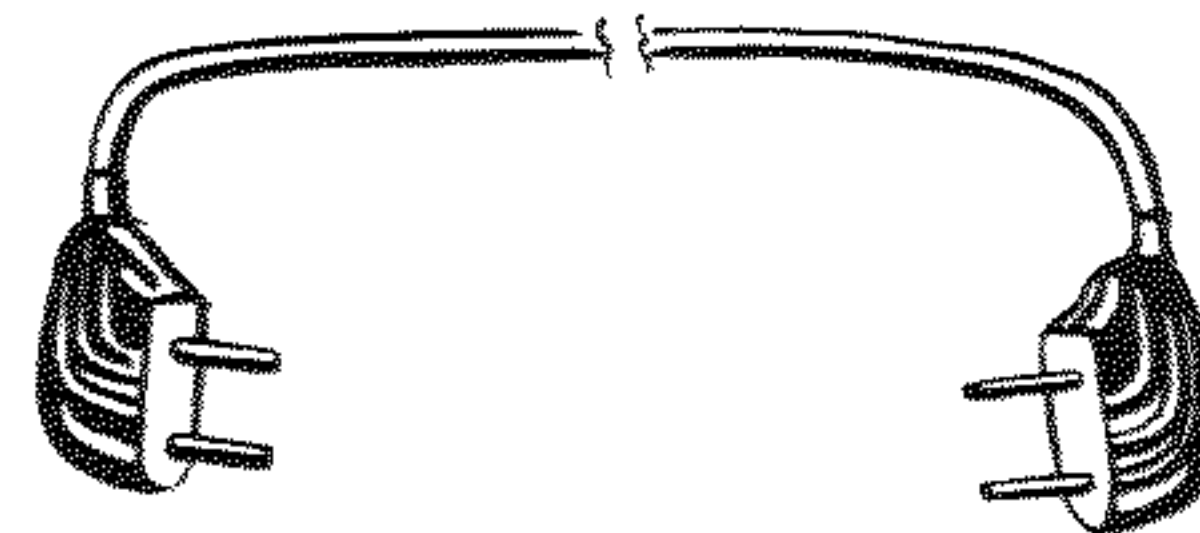

**CONNECTOR CORDS**  
Battery case to battery case  
Cat. No. Length  
2705 16"

**EXTENSION CORDS**  
Battery case to extension unit  
Cat. No. Length  
2706 15'

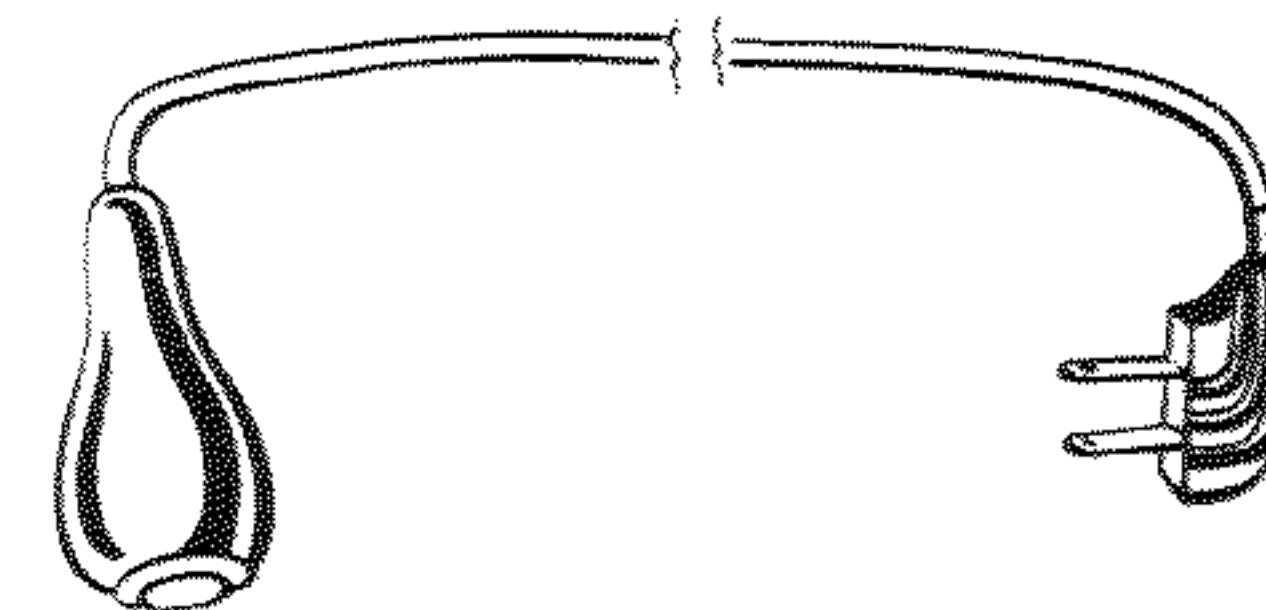

**REMOTE CONTROL CORDS**  
Remote control with momentary  
switch  
Cat. No. Length  
2720 15'

# ACCESSORIES

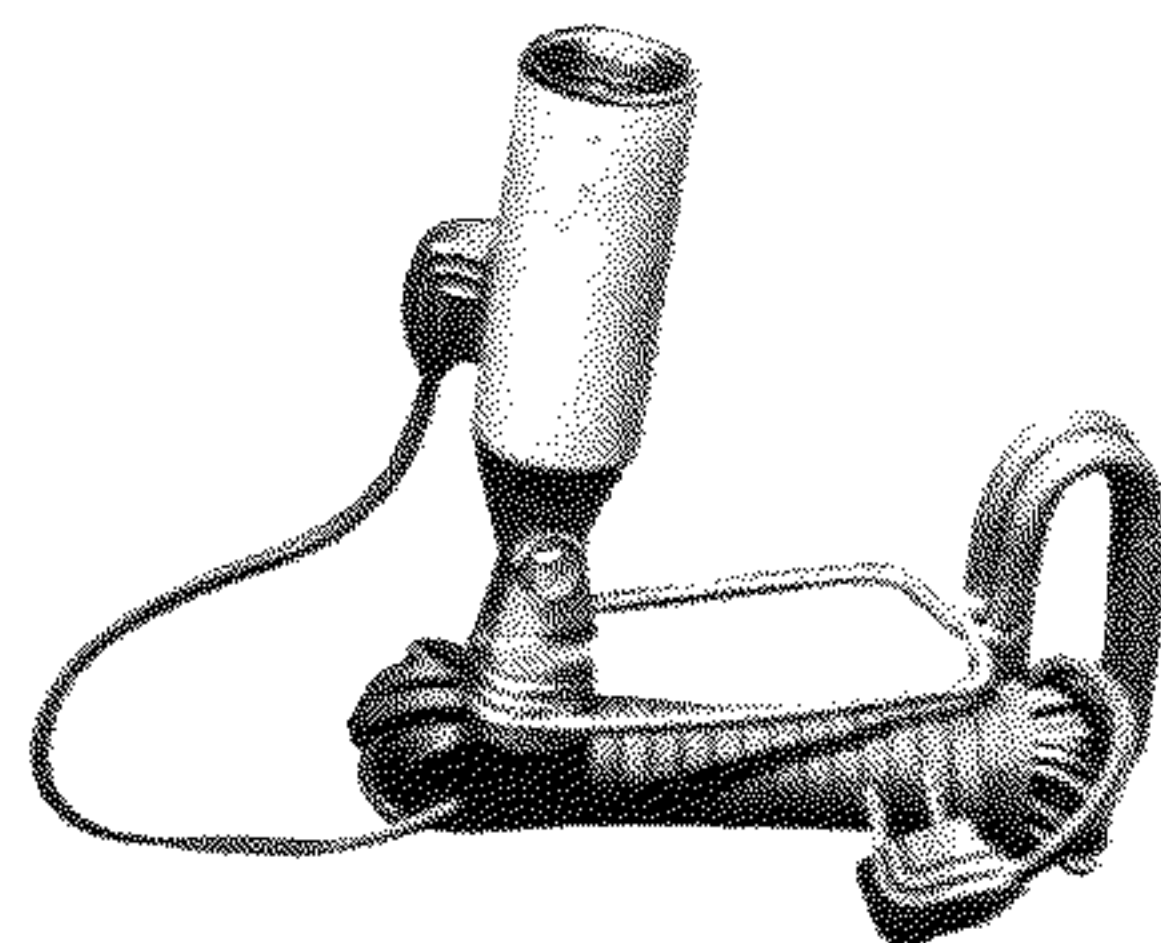

**GRAFLITE Side**  
Lighting Unit  
Including 15'  
extension cord, less  
reflector  
Cat. No. 2712

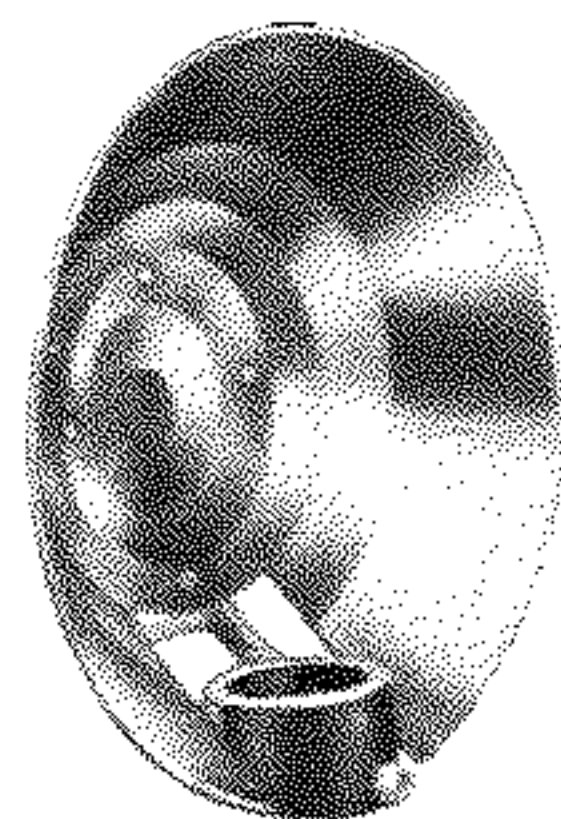

**7" REFLECTOR**  
for medium base  
lamps  
Cat. No. 2747

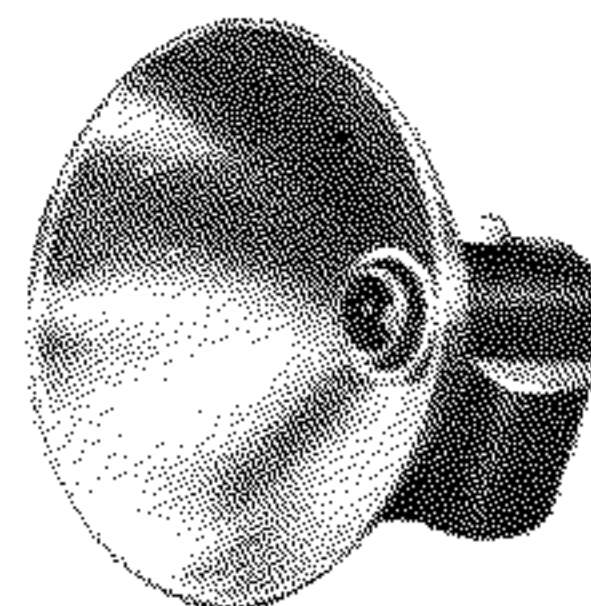

**5" REFLECTOR**  
for bayonet base  
lamps  
Cat. No. 2749

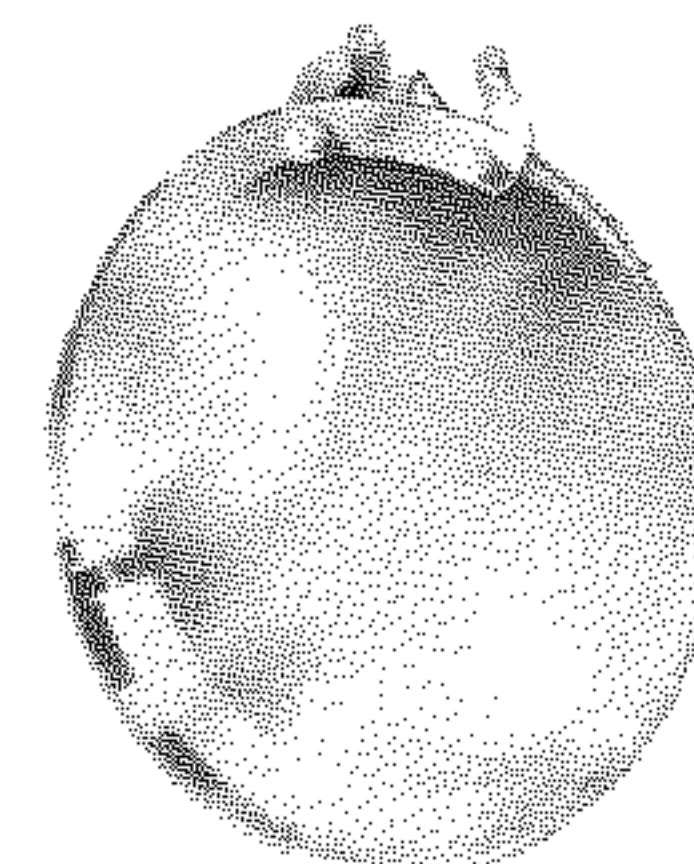

**SHIELD FOR**  
5" REFLECTORS  
Will fit all  
**GRAFLEX 5" Re-**  
flectors  
Cat. No. 2746  
Diffusion Disc  
Cat. No. 2744

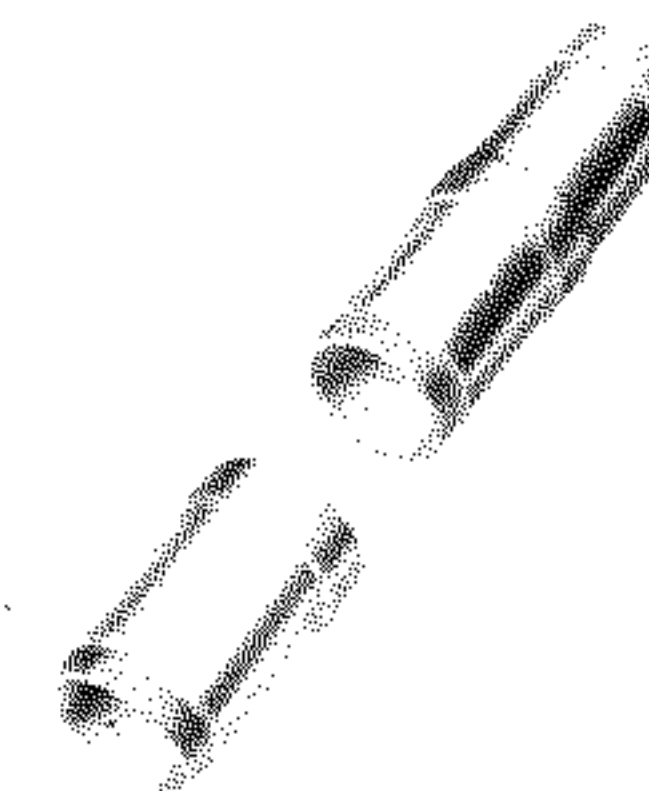

**EXTENSION**  
TUBES  
may be used in  
multiple  
Cat. No. 2774



## **P O W E R   F O R E X T E N S I O N S**

The following table will outline GRAFLITE extensions that may be used when batteries are supplying at least 7 amperes in the circuit.

This includes the operation of a solenoid and flashing one lamp in the battery case. Emergency or special cords may be made using No. 18 copper stranded wire. For best results, solder connections and clean all contacts.

Batteries	Extension with 15' cord
3 cell	1
4 cell	2
5 cell	3
*6 cell	4

\*The use of "Combined Power" is recommended. See page 15 of the GRAFLITE instruction manual.

## **G R A F L I T E 5" R E F L E C T O R A D J U S T M E N T S**

"The GRAFLITE 5" Reflector is complete with beam control." The normal position produces even illumination over a 60° angle, which amply covers the angle covered by most lenses used with Crown GRAPHIC and Speed GRAPHIC Cameras.

The full forward position of the reflector produces a beam focus adjustment concentrating the light with greater intensity into a 40° beam. At this position an increased amount of illumination will be thrown on the central part of the picture area. This amounts to a difference of from approximately 1/2 to 1 full stop opening.

Certain of the reflectors are collapsible into a back position where the word "normal" cannot be seen. If used in this position, more light will be thrown in the 25° zone than at the center. Consequently, such reflectors should not be used in this fully collapsed position.



## **GRAFLITE DIFFUSION DISC FOR 5" REFLECTOR SHIELD**

The diffusion disc may be used with or without the clear, transparent part of the shield for 5" reflectors. Loosen the two knurled lock nuts at the hinge of the shield allowing the plates to separate so that the diffusion disc can be slipped in place, with the matte side inward. Lock in place by tightening the knurled nuts. The Diffusion Disc will provide a little softer light, but no adjustment need be made when black and white films are used. When color films are used, the lens may be opened as much as  $\frac{1}{2}$  diaphragm stop.

## **SIDE LIGHTING UNIT**

Attach 5" reflector so that locking screw engages the small tip or stud in the small lower hole in the front of the housing, insuring proper electrical contact. Assemble 7" reflector so that the bulb release button will engage the ring in one of the upper holes. See chart on page 17 for use of extra batteries.

## **CARE OF GRAFLITE**

Cleanliness of equipment will insure its proper operation and full use of light produced by the flash lamp.

It is important to keep all contact surfaces clean and bright. The prongs of the solenoid cords are silver plated to produce a better contact. Do not clean these with abrasive material. Keep them and the contact posts for the battery case clean by polishing with a cloth dipped in carbon tetrachloride or other suitable non-corrosive solvent.

As with any electrical equipment, do not jerk or yank the connecting cords, or attempt to stretch them out when they should be untwisted.

Reflector surfaces which are dull or smudged will not reflect as much light as the same surface when brightly polished. The use of a little carbon tetrachloride or other non-corrosive solvent will remove smudges which cannot be removed by polishing with a clean, dry cloth.

If the lamp flashes, but the solenoid does not always operate, or if the solenoid operates and sometimes lamps on extension cords do not flash, check the cords carefully for a broken wire. To check, insert old batteries in the battery case and hold down the main switch, while twisting or jiggling the cord to the solenoid. A broken wire will be indicated if the solenoid does not remain energized all of the time the switch is closed. In the case of an extension cord, use a small test lamp in the socket at the end of the cord and close the main switch at the back of the battery case while moving the cord. A flickering lamp will indicate a broken connection.

**DISCONNECT ALL CORDS.** To avoid possible accidental shorting out of the batteries with subsequent corrosion in the battery case, it is recommended that connecting cords always be removed from the outlets in the battery case before the battery case is put away. To keep the connecting cord with the battery case, merely loop it around the case once or twice and tie in a loose knot. Under no circumstances should both ends of the cord be plugged into the same battery case.



# ADJUSTMENT OF SOLENOID

When using extension tubes the additional battery strength will require turning the adjustment cap of the solenoid upward by approximately one full turn for each additional battery cell. Approximately two full turns will also be required when using a Hot Shot battery if this is plugged into the BATTERY outlet and used as supplementary battery strength. Remember to readjust the solenoid before returning to the use of only three battery cells.

GRAFLEX Solenoid Releases are adjusted at the factory to cause the shutters, to which they are adjusted, to be fully open 18 to 20 milliseconds after the circuit is closed by the main switch. The retaining spring on the adjusting head will prevent this adjustment from being accidentally changed by vibration, shaking or normal use.

If it is desired to shorten the time interval between the closing of the electrical circuit and operation of shutter, the adjusting head should be turned down (to the right as viewed from above) until the desired time-delay is obtained; to lengthen the time interval between closing of the electrical circuit and operation of the shutter, adjusting head should be turned up until the desired timing is effected.

Adjusting the position of the solenoid in its mount is required when the factory setting has been disturbed. Proceed as follows:

NOTE: To prevent undue strain on good batteries, use old batteries for preliminary adjustment but use fresh ones for the final test).

Remove the lensboard from the camera:

Slightly loosen the clamp screw in the solenoid mount, so that the solenoid release may be moved vertically;

Connect the release link with the shutter-release lever;

Set the shutter at its top speed and cock it;

Connect the solenoid with one of the parallel outlets in the front of the battery case by means of the connecting cord;

Close the main switch on the battery case and hold it closed so that the armature remains down;

Slowly move the solenoid away from the shutter until the shutter just releases;

Open the main switch;

Hold the solenoid in this exact position and tighten the clamp screw.

The solenoid armature should be at the bottom of its stroke when the shutter release lever is at the point of tripping. To test this, cock the shutter and move the release lever down very slowly by hand. At the exact point where the lever releases the shutter, energize the solenoid by pressing the red button of the main switch. This should not cause any further movement of the release lever and, if the adjustments have been made correctly (the switch being kept closed during this process) the finger can be removed from the release lever without the latter moving back.

Slowly unscrew the solenoid cap, meanwhile operating the shutter frequently at 1/400 by energizing the solenoid. Continue this process as long as the solenoid will continue to operate the shutter.



## ***ADJUSTMENT OF SOLENOID (Continued)***

The "Time" and "Bulb" positions should now be tested, using fresh batteries. When cocking the shutter in the "Time" and "Bulb" positions, allow at least one second after cocking before pressing the main switch. The shutter may operate satisfactorily at both positions without making any further adjustments. If it does not, note the following faults and their remedies:

1. The shutter may fail to open because the solenoid is not adjusted properly. To correct this, screw the solenoid cap down slowly until the shutter does operate, testing after each slight turn.
2. An occasional shutter may not hold its open position as it should on "Time" and "Bulb" exposures—that is, it may slide past the open position in a manner similar to its operation on the instantaneous settings. If it does this, even when there has been a pause after cocking the shutter, the shutter should be adjusted at the factory.
3. If the solenoid opens the shutter on "Time" or "Bulb" settings, but fails to close it again, try closing the shutter manually by operating the release lever. If it is found that the shutter did not latch after the opening movement of the release lever, the closing movement cannot be accomplished.

This calls for adjustment to the shutter, providing that the solenoid cap was not screwed down farther than necessary, as described in (1) above.

4. If the release lever does not latch after the opening movement, but the solenoid armature travel was not sufficient to accomplish the closing movement, the solenoid release must be re-set vertically in its mount as described above. In this case, instead of having the shutter set at the highest instantaneous setting, the adjustments should be made with the release lever latched and ready to close the shutter on the "Time" setting.

Having reset the shutter in this manner, the solenoid should operate it for both the "Time" and "Bulb" settings with, perhaps, some adjustment of the solenoid cap. If it is not possible to get satisfactory shutter operation by carefully following the above procedure, the shutter should be repaired.

Test synchronization by making negatives or by using a reliable testing device, which does not upset the synchronizer circuit. Be sure that it is in proper adjustment and is correctly operated, since otherwise erroneous readings may be obtained.



# COMBINATIONS & PRICES

Cat. No.		Price
2725	GRAFLITE No. 25 Unit (2-cell with 5" reflector)	\$25.95†
2727	GRAFLITE No. 27 Unit (2-cell with 7" reflector)	24.95†
2735	GRAFLITE No. 35 Unit (3-cell with 5" reflector)	27.45†
2737	GRAFLITE No. 37 Unit (3-cell with 7" reflector)	26.45†
2736	GRAFLITE No. 35 Synchronizer (3-cell with 5" reflector)	40.65*
2738	GRAFLITE No. 37 Synchronizer (3-cell with 7" reflector)	39.65*

† Does not include cord or mounting plate.

\* Does not include mounting plate or installation.

## GRAFLITE Mounting Plates and Brackets

2754	Flat mounting plate	1.10
2753	Rangefinder encircling bracket for Pacemaker "34's" and "45's" with rangefinders	2.65
2755	Mounting plate for Pacemakers without rangefinder	2.10
2758	L-Bracket for Pacemaker "23's" with rangefinder	2.80

## Other GRAFLITE ACCESSORIES and REPLACEABLE PARTS

Cat. No.		Price
2712	GRAFLITE Side Lighting Unit, including No. 2706 15' extension cord, less reflector	\$16.00
2747	7" GRAFLITE reflector for medium base lamps	6.50
2749	5" GRAFLITE adjustable reflector for bayonet base lamps	7.50
2746	Shield for GRAFLITE or GRAFLEX 5" reflector	4.20
2774	GRAFLITE 1-cell extension tube (may be used in multiple)	1.50
2701	20" GRAFLITE synchronized shutter cord	1.40
2702	36" GRAFLITE synchronized shutter cord	1.60
2703	17" GRAFLITE solenoid cord	1.20
2704	36" GRAFLITE solenoid cord	1.60
2705	16" GRAFLITE twin case connector cord	1.05
2706	15' GRAFLITE extension cord	1.50
2720	15' GRAFLITE remote control cord with momentary switch	2.90

Prices subject to change without notice.

GRAFLEX, Inc., Rochester 8, N. Y.

# GRAFLITE

# BY GRAFLEX

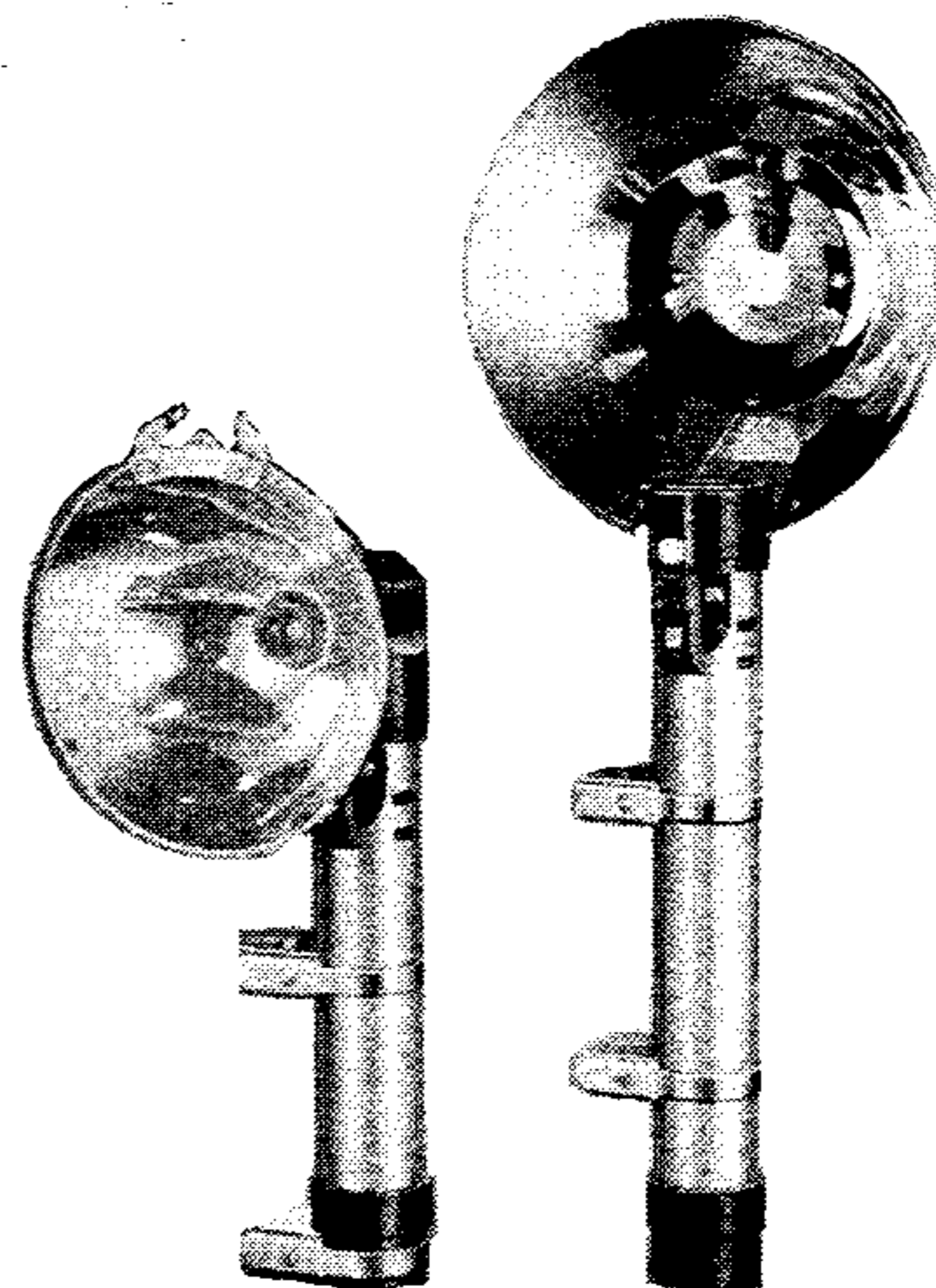

Featuring

- ★ VERSATILITY
- ★ DEPENDABILITY
- ★ SIMPLICITY



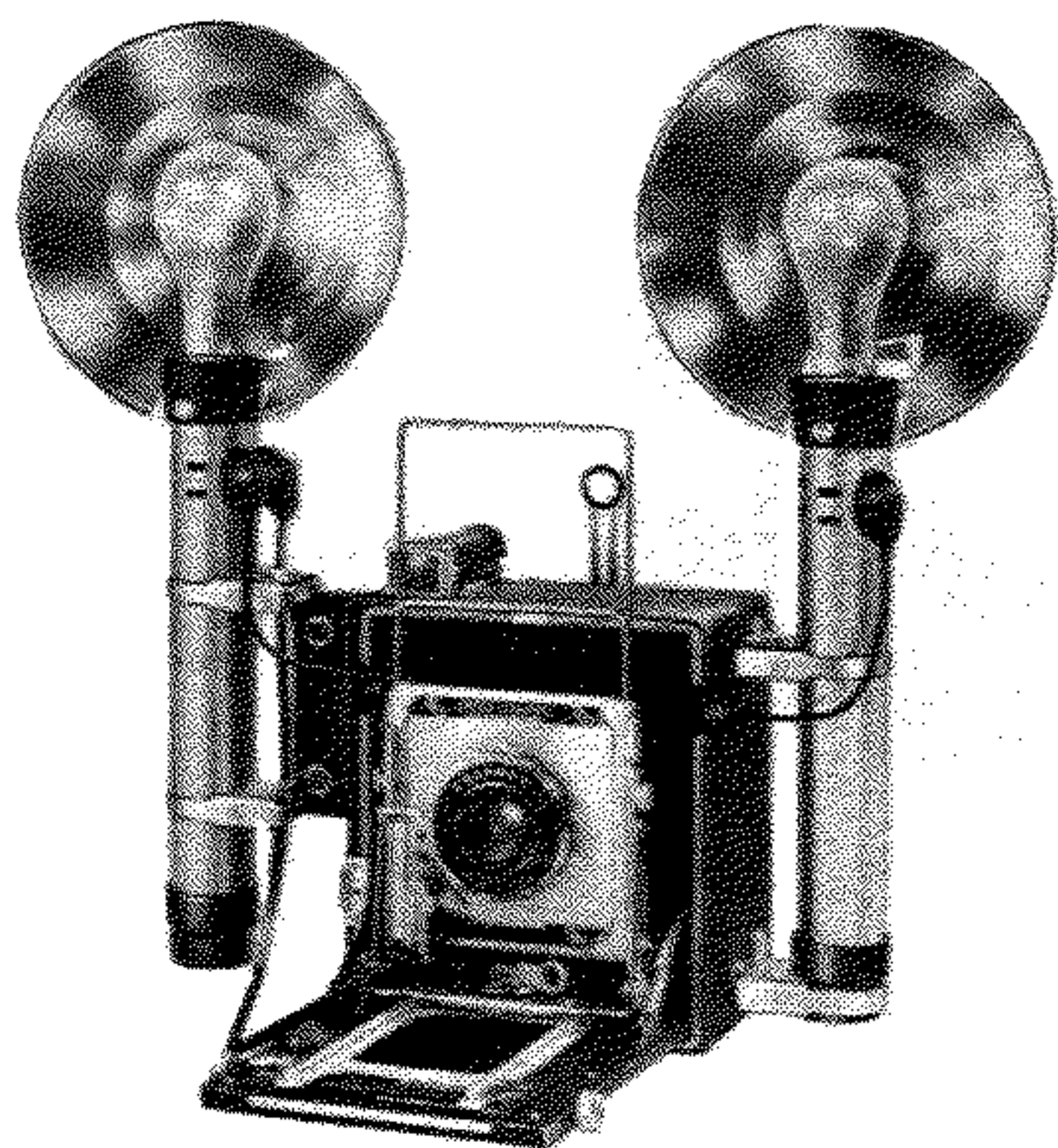

The heavy-duty supporting clamps (standard equipment) are movable, allowing the battery case to be placed either on the right side or attached to handle lugs on left side, with switch at front or back.

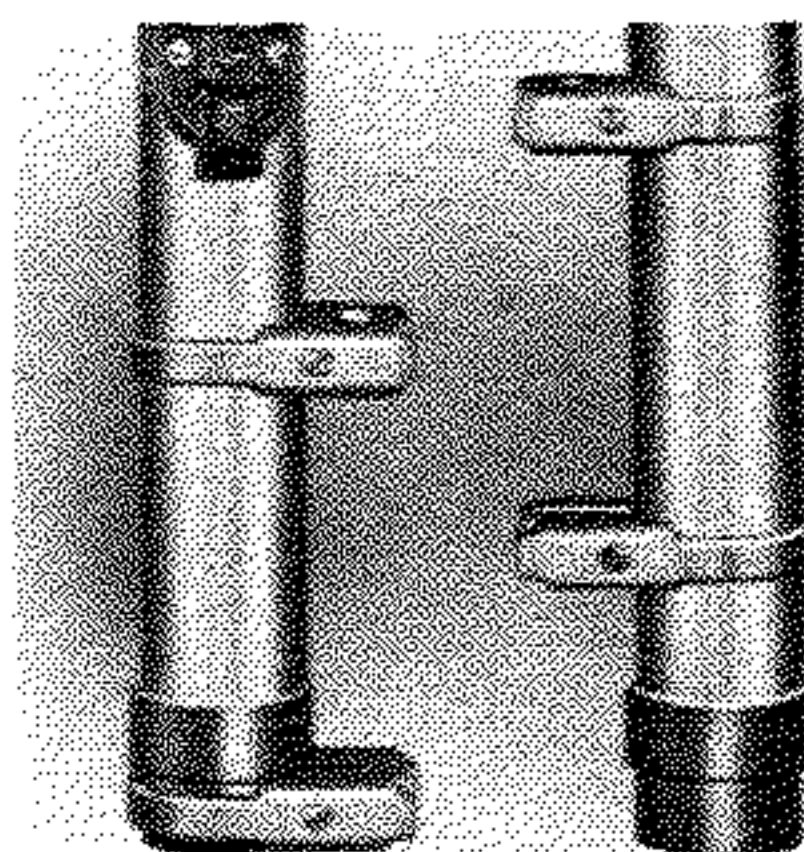

Handy extension tubes, each accommodating one dry cell, may be joined together in multiple for whatever power may be required.

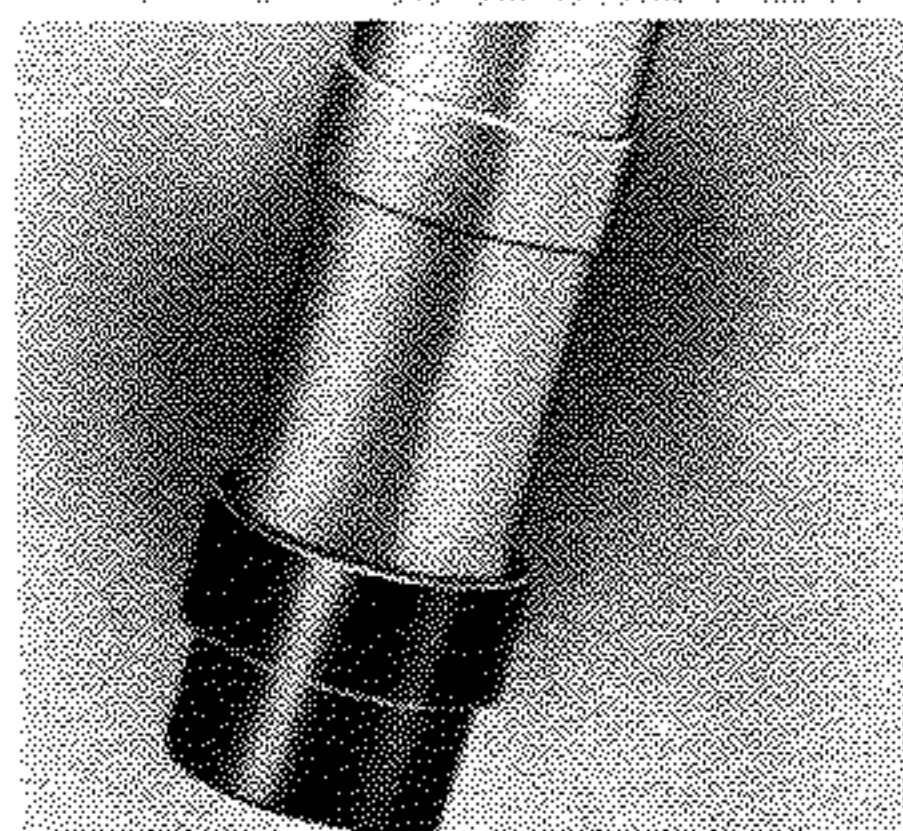

The push button lamp ejector of both 5" and 7" reflectors conveniently pops out the fired bulb, speeding up the loading—flashing—ejecting cycle.

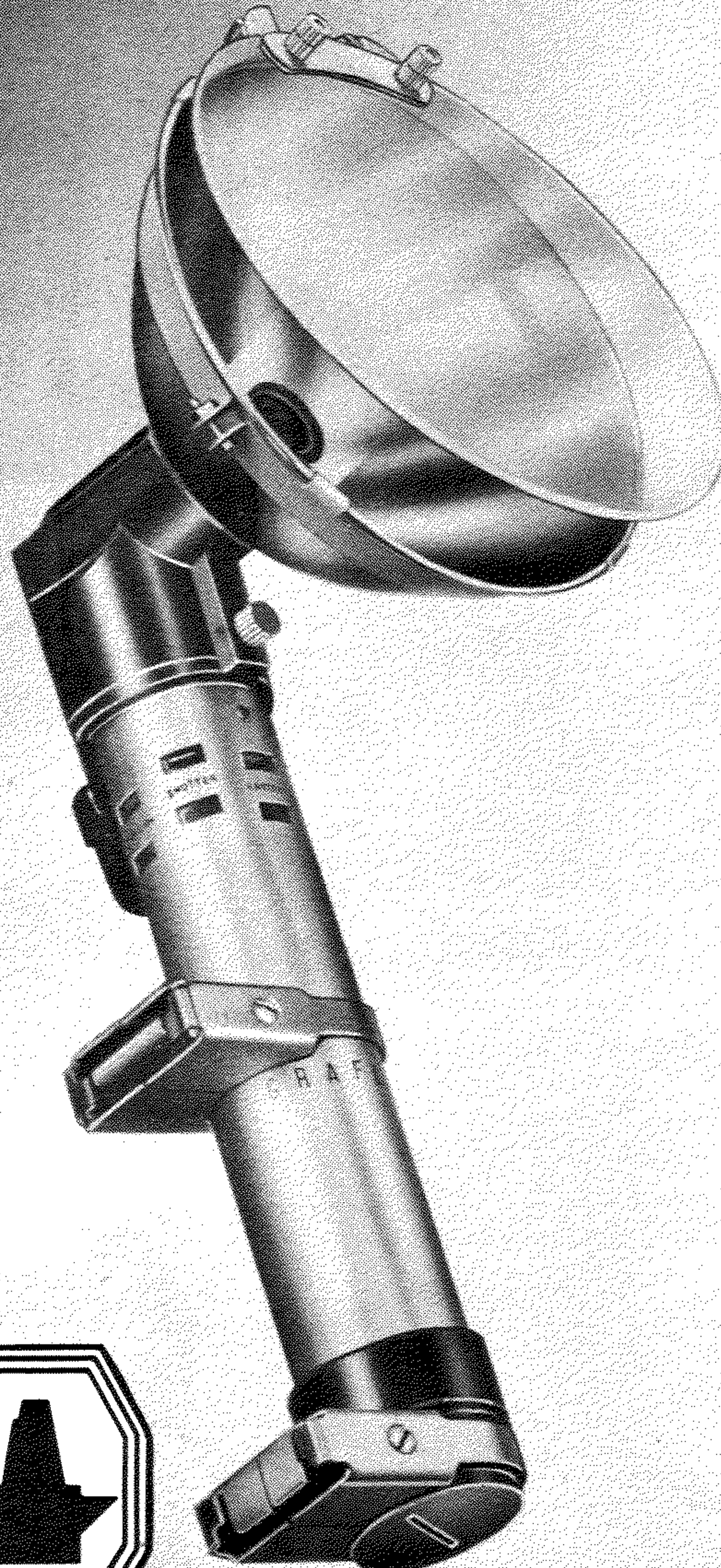
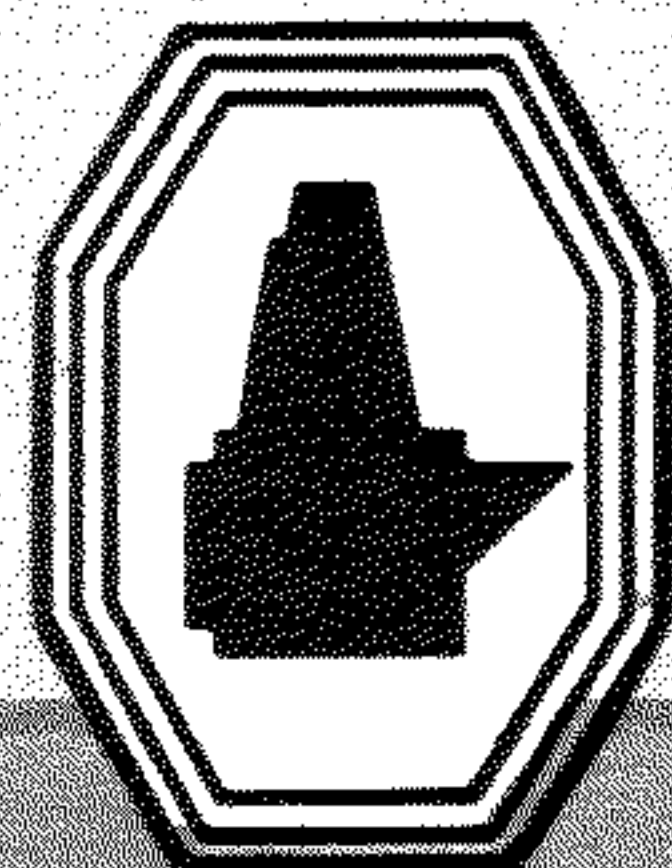
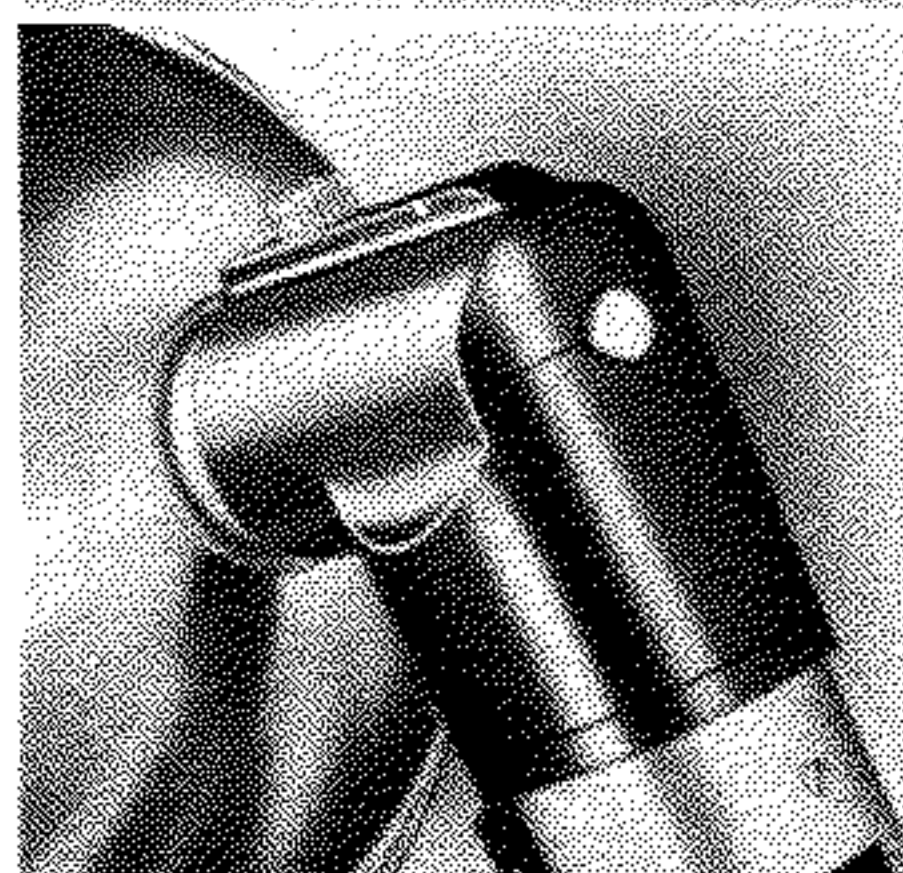



# GRAFLITE by Graflex

Ease of operation of the latest in flash equipment makes it the unit desired by amateur photographers. Undreamed of versatility makes it the unit required by professionals. Its dependability, sleek new styling and surprising light weight will appeal to all. A powerhouse for synchronized shutters as well as solenoid-operated shutters.

The combined power of the twin battery cases shown at right may be used to provide the increased power so necessary to fire dependably the extra flash lamps required for synchronized color photography.

Here is flash equipment to meet the most exacting requirements—precision built by Graflex.

The multi-purpose circuit controller affords the selection of three circuits, giving you a possibility of numerous connections and uses to meet every requirement.

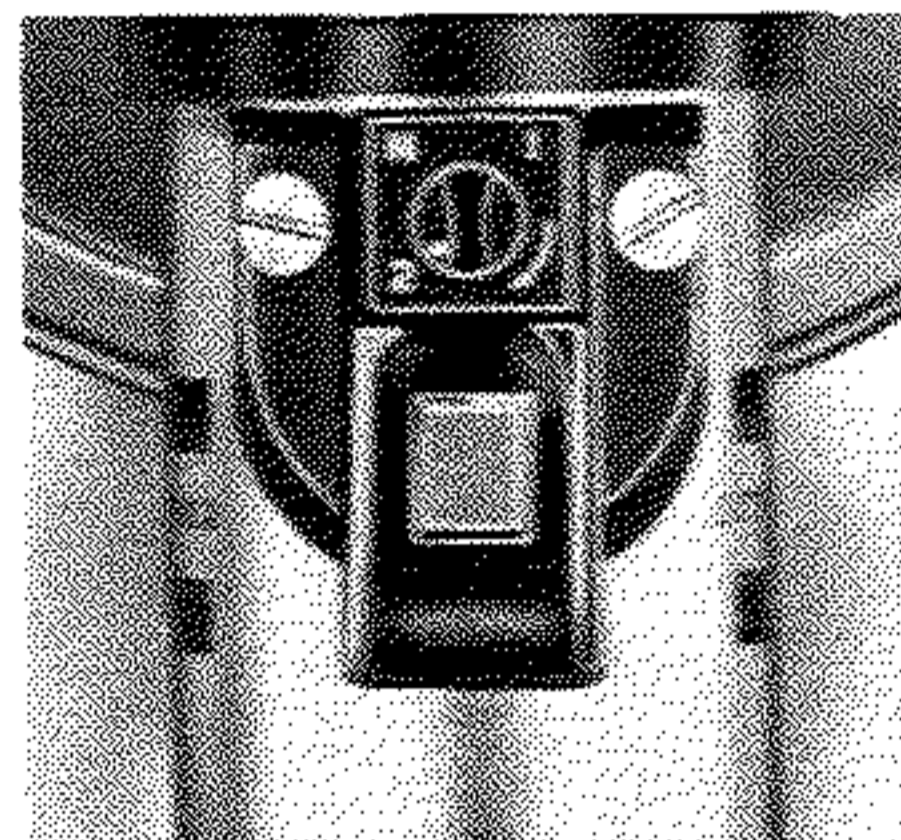

No sliding, twisting or turning is necessary with the heavy-duty supporting clamps. Just "snap on" for a vise-like grip—to remove, press *one* button!

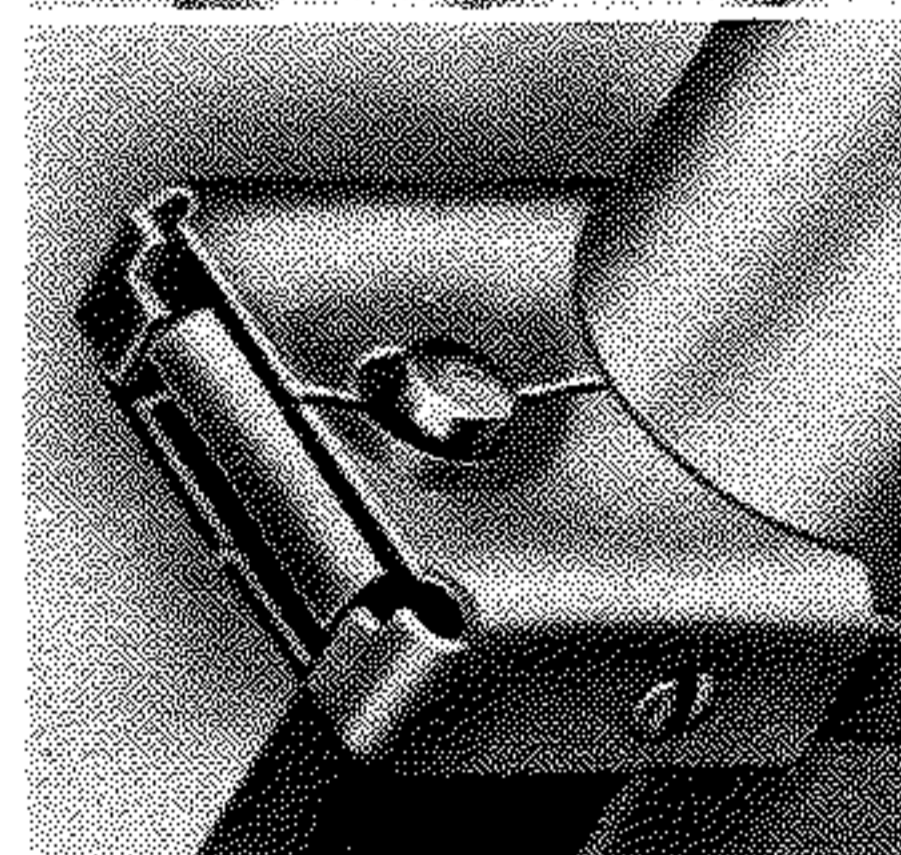

Either 5" bayonet or 7" medium base reflector may be easily attached to battery case (while case is on camera) with main switch at *either* front or rear of the battery case.

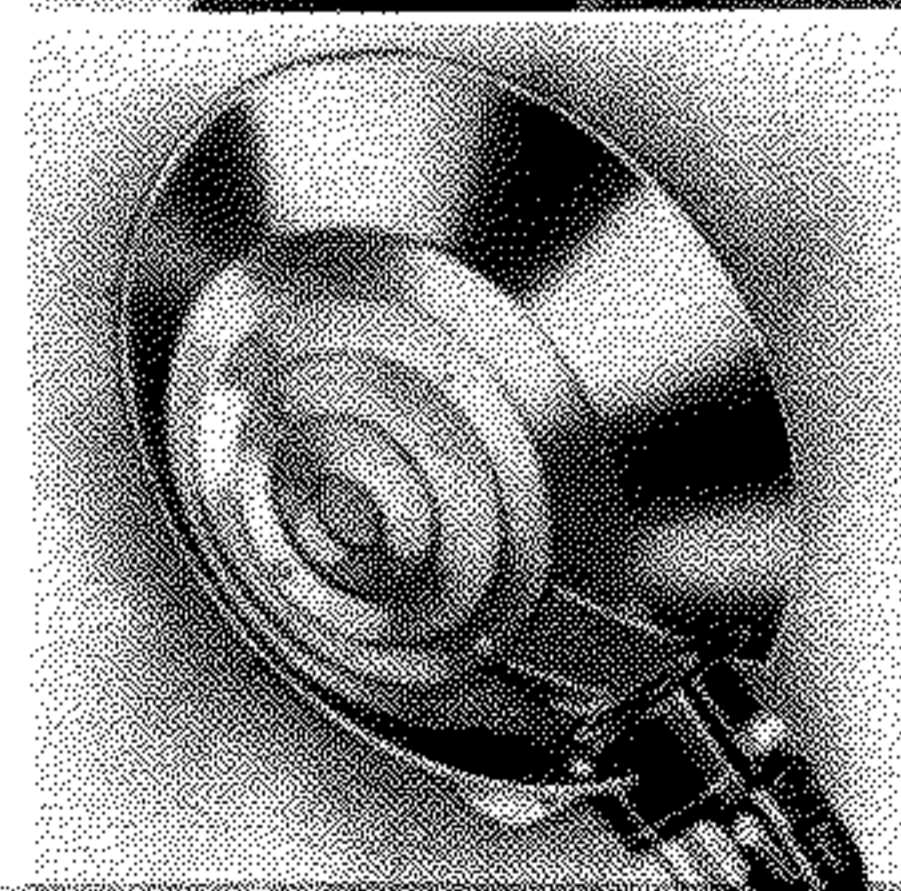

Around the top of battery case are 5 outlets, each clearly marked for its intended use. These multiple outlets give an indication of the unusual versatility of Graflite.

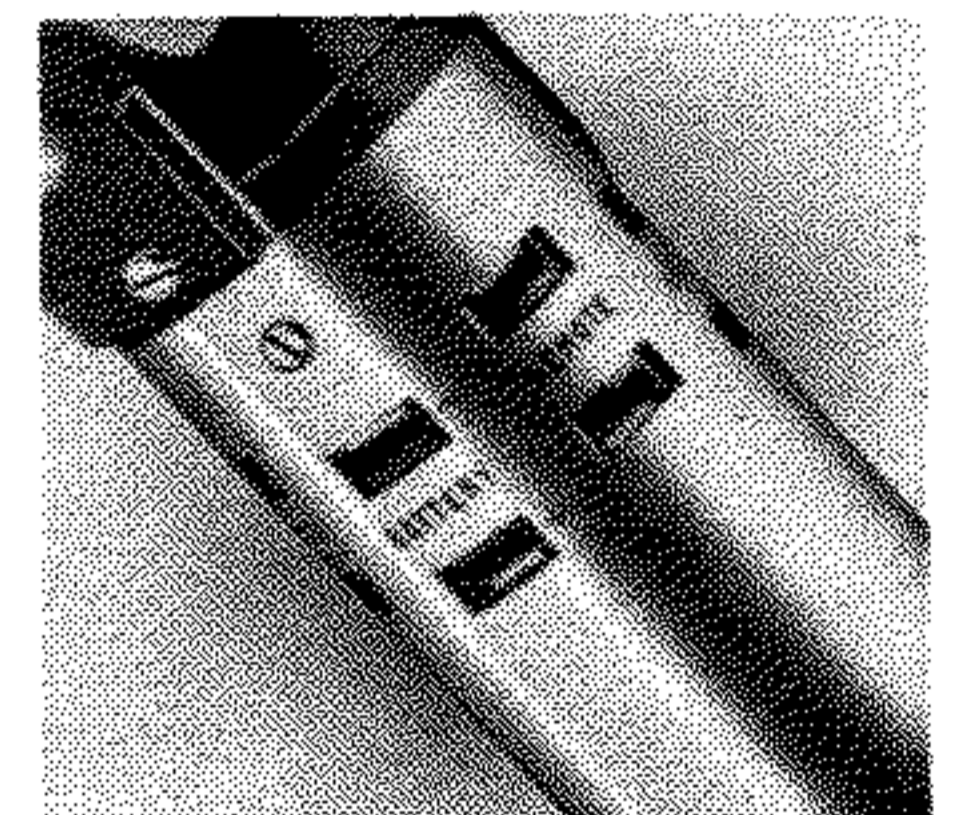

Standard household plug connections—positive, sturdy, easy to insert and remove—are one of the multitude of features that mean the finest in flash.

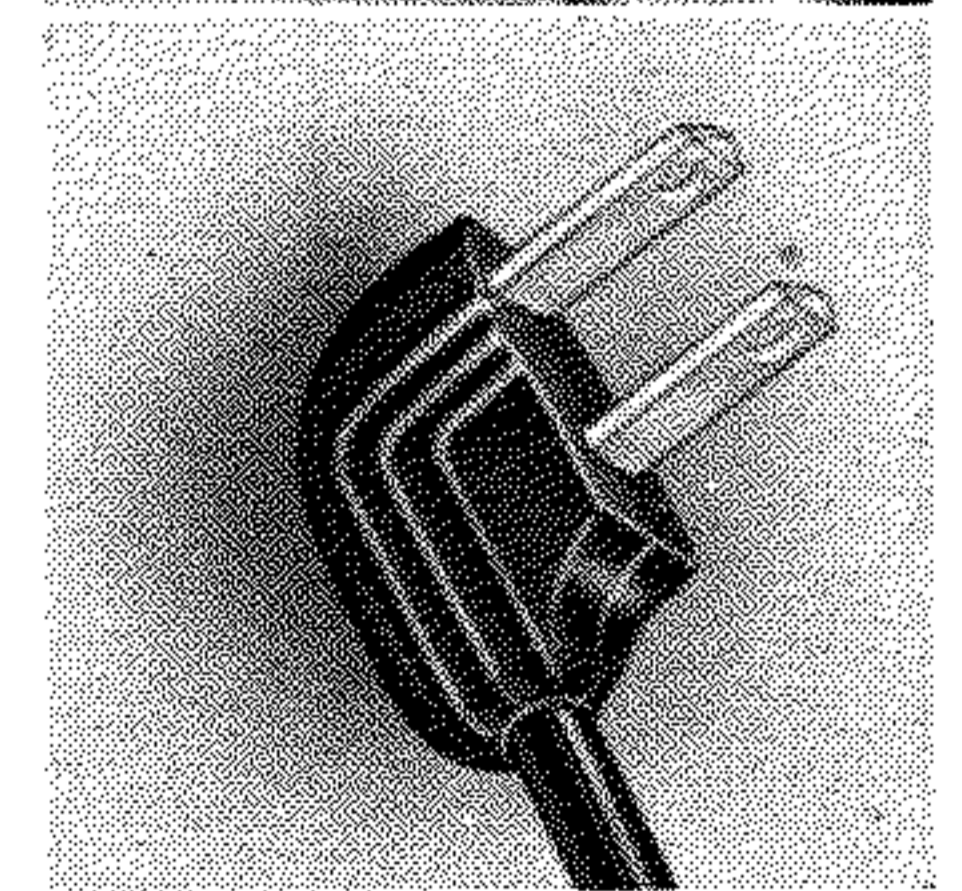

The new micro-type, click action switch makes positive contact easily, with no camera movement, and gives an audible signal of contact.

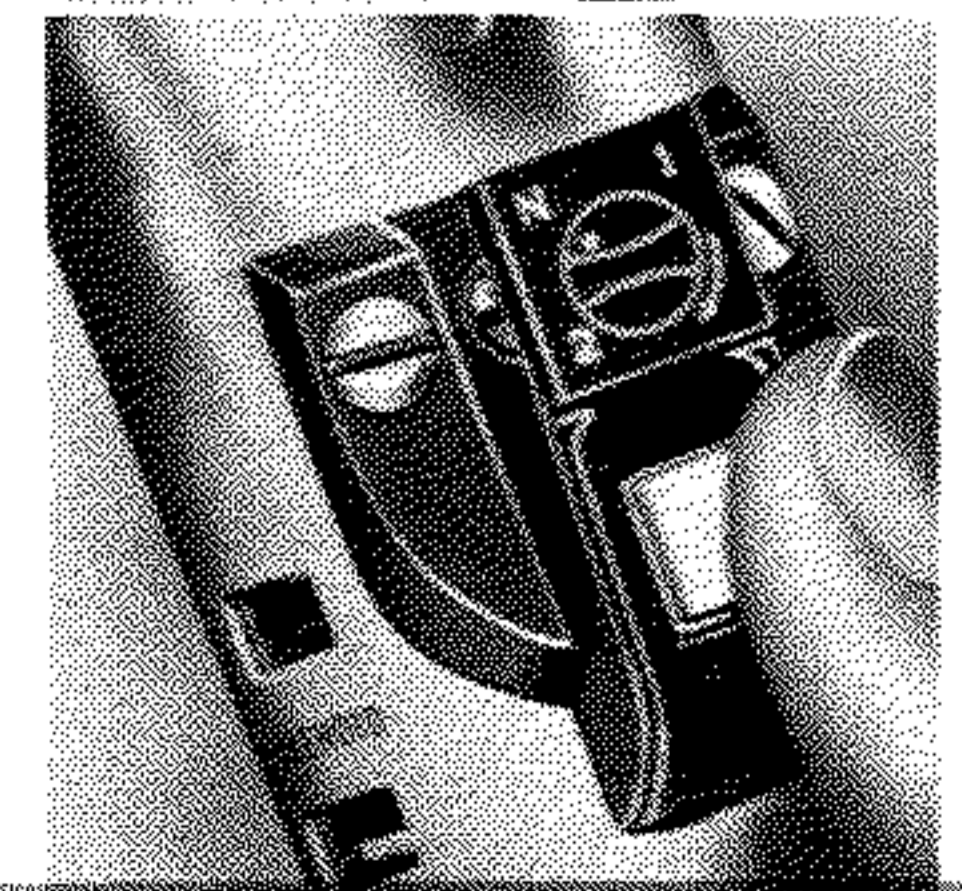

ER 58 YEARS' EXPERIENCE IN MAKING PRECISION



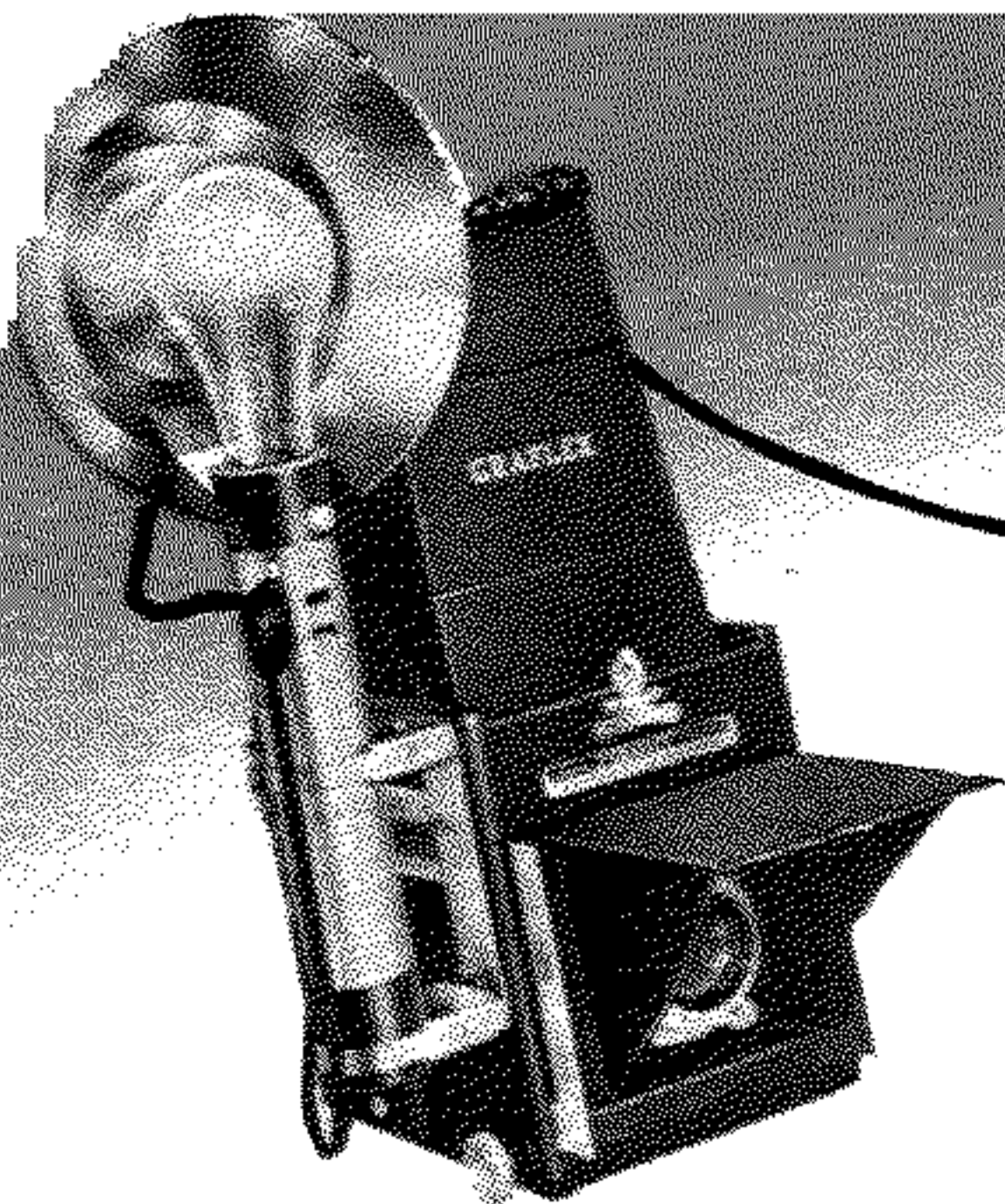

# GRAFLITE *Accessories*

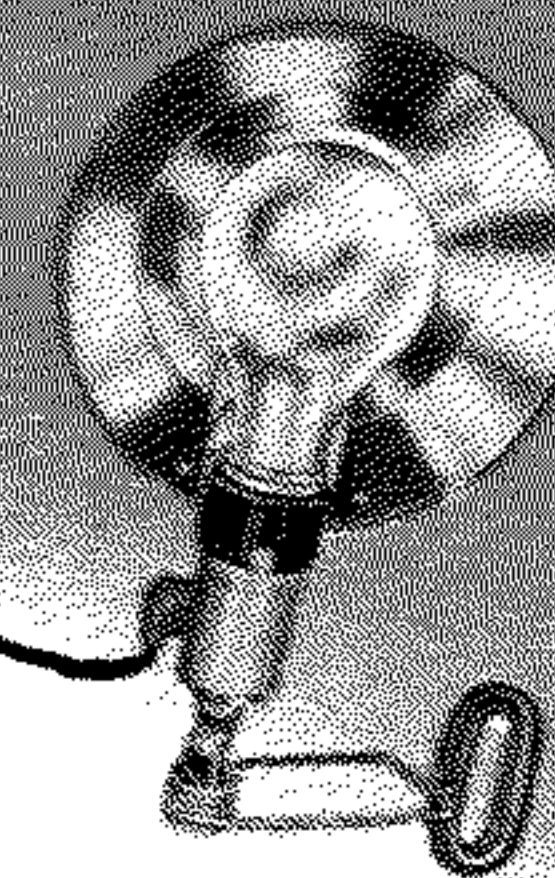

## CONNECTING CORDS

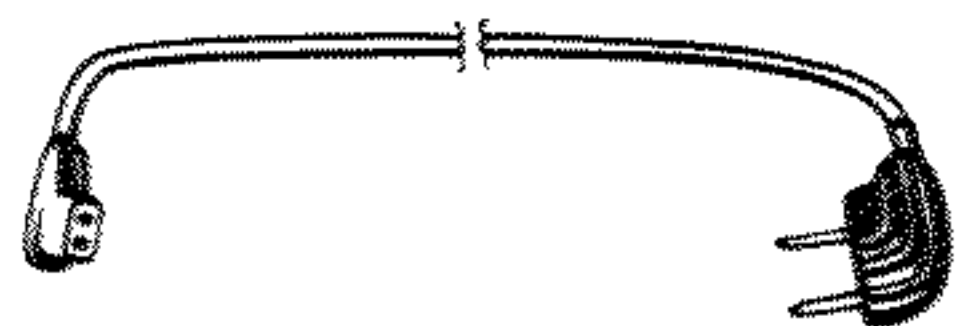

**SHUTTER CORDS**  
*Synchronized shutter to*  
**SHUTTER Outlet**

Cat. No.	Length
2701	20"
2702	36"



**SOLENOID CORDS**  
*Solenoid to SOLENOID*  
**Outlet**

Cat. No.	Length
2703	17"
2704	36"



**CONNECTOR CORDS**  
*Battery case to battery case*

Cat. No.	Length
2705	16"

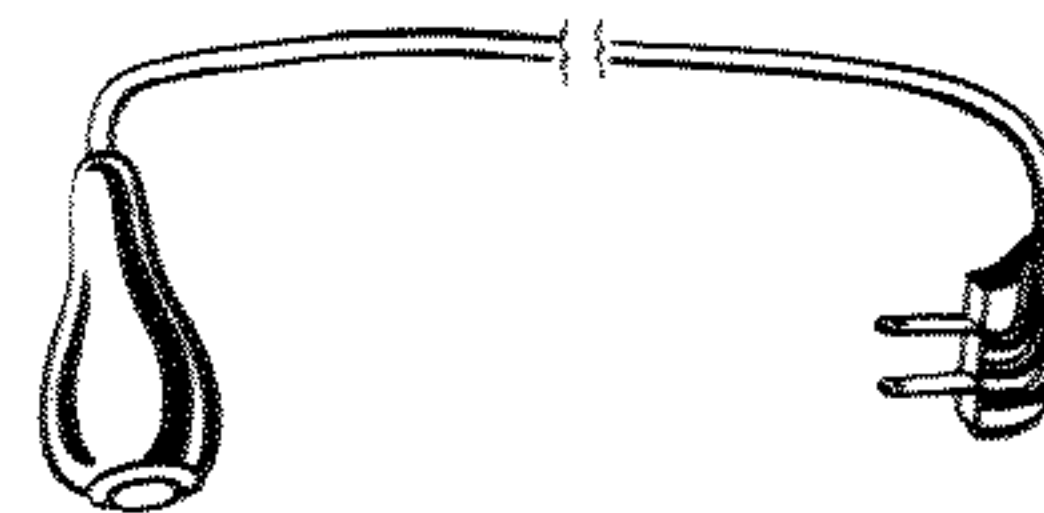

**REMOTE CONTROL CORDS**  
*Remote control with momentary switch*

Cat. No.	Length
2720	15'

**EXTENSION CORDS**  
*Battery case to extension unit*

Cat. No.	Length
2706	15'

## ACCESSORIES

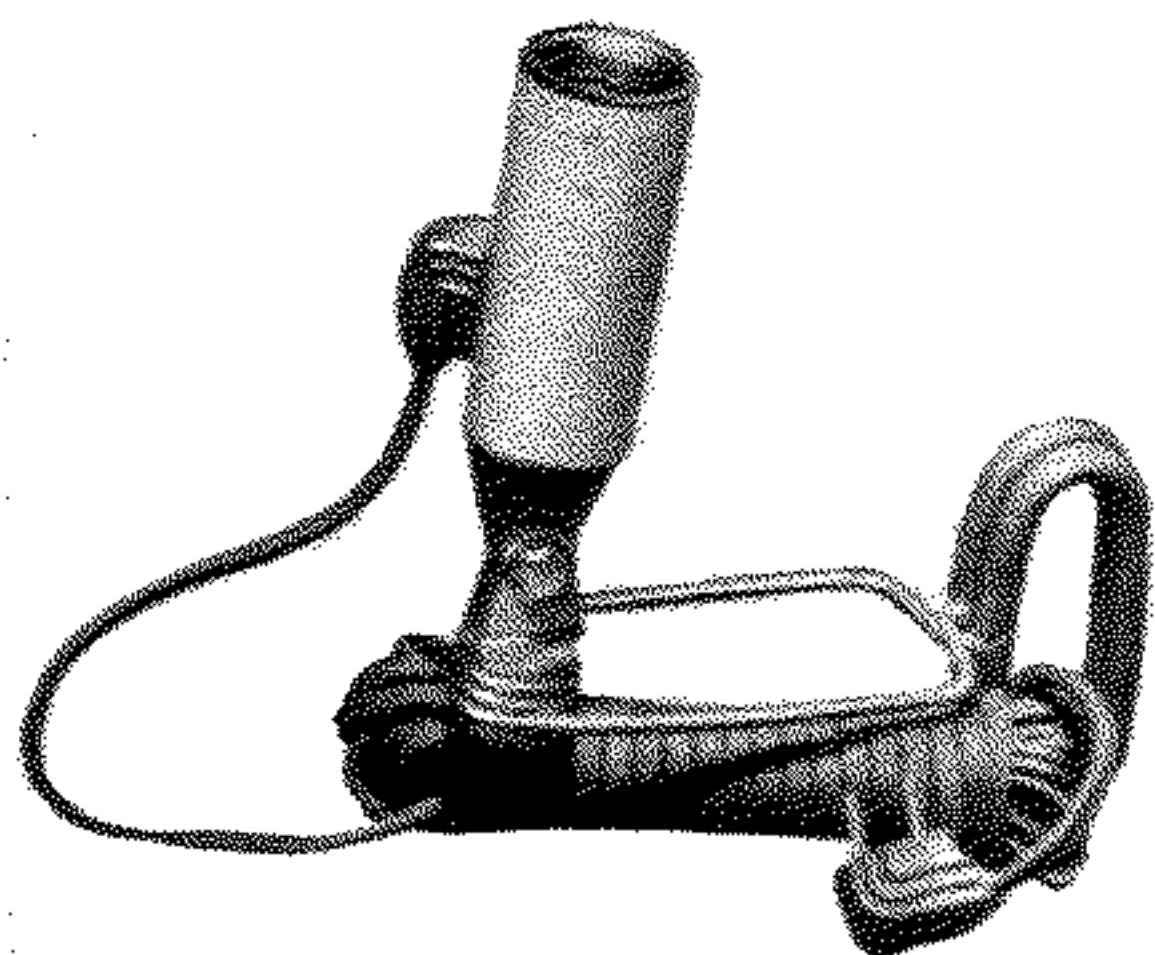

**GRAFLITE Side**  
**Lighting Unit**  
*Including 15' extension*  
*cord*  
*less reflector*

Cat. No.  
2712

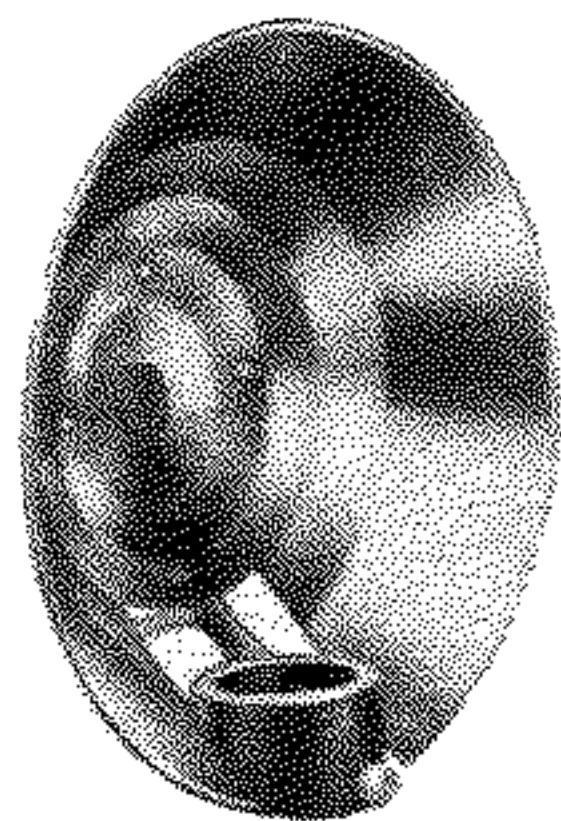

**7" REFLECTOR**  
*for medium base lamps*  
Cat. No. 2747

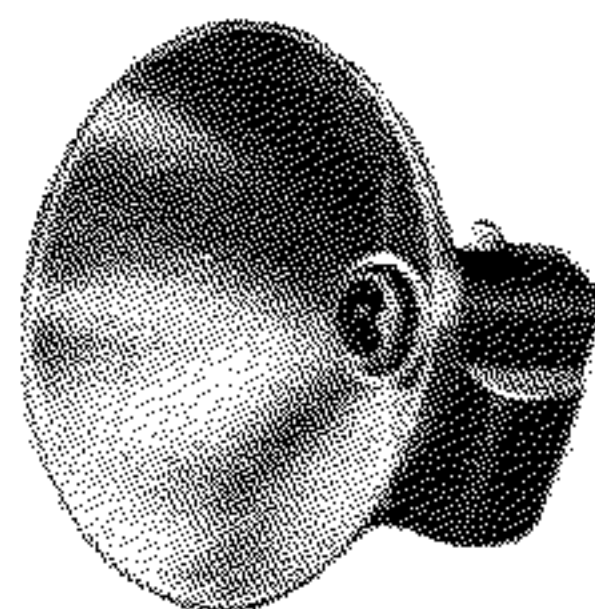

**5" REFLECTOR**  
*for bayonet base lamps*  
Cat. No. 2749

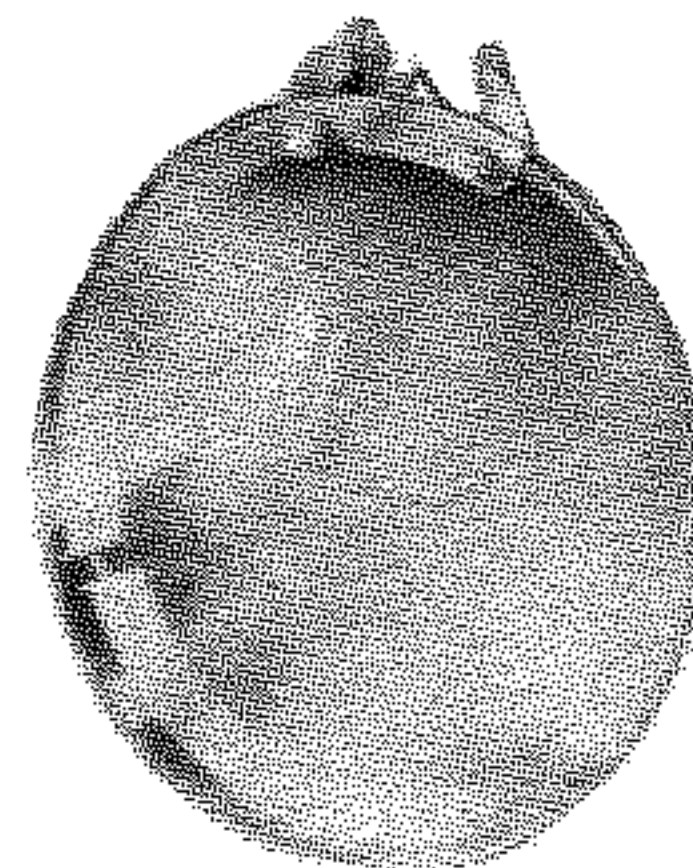

**SHIELD FOR**  
**5" REFLECTORS**  
*Will fit all GRAFLEX*  
*5" Reflectors*  
Cat. No. 2746

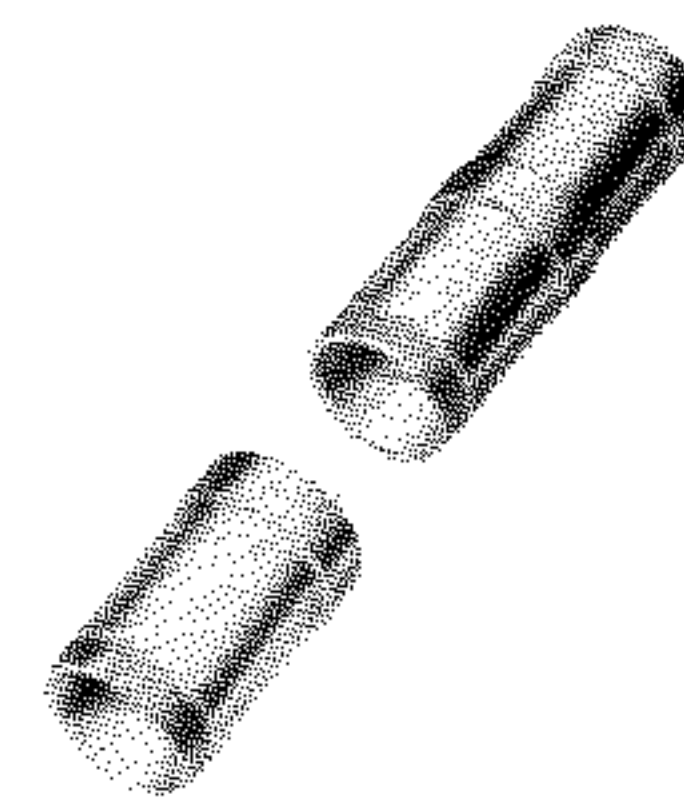

**EXTENSION**  
**TUBES**  
*may be used in multiple*  
Cat. No. 2774